

**US ARMY TM 10-8415-209-10
US MARINE CORPS TM 8415-10/2**

**OPERATOR'S MANUAL
FOR
INDIVIDUAL CHEMICAL
PROTECTIVE CLOTHING**

**Distribution Statement A: Approved for public release;
A distribution is unlimited.**

**CHAPTER 1
INTRODUCTION**

**CHAPTER 2
OPERATING INSTRUCTIONS**

**INTRODUCTION TO
PMCS TABLE**

**CHAPTER 3. OPERATOR
MAINTENANCE INSTRUCTIONS**

**APPENDIX A
REFERENCES**

**APPENDIX B
COMPONENTS OF END ITEM**

**ALPHABETIC
INDEX**

**HEADQUARTERS
DEPARTMENTS OF THE ARMY AND MARINE CORPS
31 MARCH 1993**

SUMMARY OF WARNINGS

WARNING

The following doffing procedure is to be used only when you have not been exposed to contamination. For decontamination procedures, see FM 3-5/FMFM 11-10.

a/(b blank)

TECHNICAL MANUAL
NO. 10-8415-209-10

HEADQUARTERS
DEPARTMENTS OF THE ARMY AND MARINE CORPS
WASHINGTON, D.C., 31 MARCH 1993

**OPERATOR'S MANUAL
FOR
INDIVIDUAL CHEMICAL PROTECTIVE CLOTHING**

REPORTING ERRORS AND RECOMMENDING IMPROVEMENTS

You can help improve this manual. If you find any mistakes or if you know of a way to improve the procedures, please let us know. Mail your letter, DA Form 2028 (Recommended Changes to Publication and Blank Forms), or DA Form 2028-2 located in the back of this manual direct to: Commander, US Army Aviation and Troop Support Command, ATTN: AMSAT-I-MTS, 4300 Goodfellow Blvd, St. Louis, MO 63120-1798. Marine Corps users, submit NAVMC Form 10772 directly to: Commander, Marine Corps Logistics Bases (Code 850), Albany, GA 31704- 5000 A reply will be sent to you.

TABLE OF CONTENTS

	<u>page</u>
CHAPTER 1. INTRODUCTION	1-1
Section I. GENERAL INFORMATION.....	1-1
1-1 Scope.....	1-1
1-2 Maintenance Forms and Procedures	1-1
1-3 Destruction Of Army Material To Prevent Enemy Use	1-1
1-4 Reporting Equipment Improvement Recommendations (EIR)	1-1
1-5 Nomenclature Cross Reference List	1-2
Section II. EQUIPMENT DESCRIPTION	1-4
1-6 Description Of Major Components	1-4
1-7 Differences Between Models	1-10
Section III. Principles OF OPERATION	1-12
1-8 General	1-12
CHAPTER 2. OPERATING INSTRUCTIONS	2-1
Section I. Preventative Maintenance Checks And Services (PMCS)	2-2
2-1 Introduction to PMCS table	2-2
Section II. OPERATION UNDER USUAL CONDITIONS	2-8
2-2 Donning the Chemical Protective Underwear (CPU)	2-8
2-3 Doffing the Chemical Protective Underwear (CPU)	2-14
2-4 Donning the Chemical Protective Overgarments (BDO, OG84, CPOG).....	2-17

2-5	Doffing the Chemical Protective Overgarments (BDO,OG84, OG84	2-23
2-6	Donning the Suit, Chemical and Biological Protective, Carbon Sphere (Saratoga)	2-27
2-7	Doffing the Suit, Chemical and Biological Protective, Carbon Sphere (Saratoga)	2-32
2-8	Donning the Aircrew Uniform, Integrated Battlefield (AUIB)	2-36
2-9.	Doffing the Aircrew Uniform, Integrated Battlefield (AUIB)	2-44
2-10	Donning the Suit, Contamination Avoidance, Liquid Protective (SCALP)	2-48
2-11	Doffing the Suit, Contamination Avoidance, Liquid Protective (SCALP)	2-53
2-12	Decals and instruction Plates	2-56

CHAPTER 3. OPERATOR MAINTENANCE INSTRUCTIONS	3-1
---	------------

3-1	General	3-1
3-2	Laundering the Chemical Protective Underwear (CPU)	3-1
3-3	Laundering the Suit, Chemical and Biological Protective, Carbon Sphere (Saratoga)	3-3

APPENDIX A. REFERENCES	A-1
-------------------------------------	------------

APPENDIX B. COMPONENTS OF END ITEM AND BASIC ISSUE ITEMS LIST.....	B-1
---	------------

Section I. INTRODUCTION	B-1
B-1 Scope	B-1
B-2 General	B-1
B-3 Explanation of Columns	B-2
Section II. COMPONENTS OF END ITEM	B-3
Section III. BASIC ISSUE ITEMS	B-18

APPENDIX C. ADDITIONAL AUTHORIZATION LIST (Not Applicable)	C-1
APPENDIX D. EXPENDABLE/DURABLE ITEMS LIST	D-1
GLOSSARY	GLOSSARY 1
ALPHABETIC INDEX	INDEX 1

HOW TO USE THIS MANUAL

This manual contains general information, operating instructions, operator preventive maintenance checks and services (PMCS) for the Individual Chemical Protective Clothing items. Use the front cover index and thumb bleeds at the edge of the pages to quickly find the sections of the manual shown on the cover.

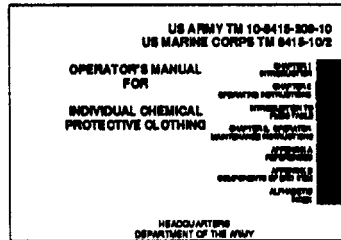

The manual is divided into Chapters, Sections and Paragraphs numbered in sequence. Pages, paragraphs and tables are numbered by chapter. For example, page 3 of Chapter 2 is marked 2-3; the second table of Chapter 1 is labeled Table 1-2. To quickly find specific information, use the table of contents on page i.

CHAPTER 1 INTRODUCTIONS

Section I. GENERAL INFORMATION

- 1-1. SCOPE.** This manual describes proper use of the various Individual Chemical Protective Clothing items.
- 1-2. MAINTENANCE FORMS AND PROCEDURES.** Department of the Army forms and procedures used for maintenance will be those prescribed by DA Pam 738-750 (The Army Maintenance Management System (TAMMS)) (Maintenance Management UPDATE).
- 1-3. DESTRUCTION OF ARMY MATERIEL TO PREVENT ENEMY USE.** Refer to TM 750-244-3 for destruction of materiel to prevent enemy use.
- 1-4. REPORTING EQUIPMENT IMPROVEMENT RECOMMENDATIONS (EIR).** If your Individual Chemical Protective Clothing needs improvement, let us know. Send us an EIR. You, the user are the only one who can tell

us what you don't like about your equipment. Let us know what you don't like about the design or performance. Put it on an SF 368 (Product Quality Deficiency Report). Mail it to us at Commander, U.S. Army Aviation and Troop Support Command, ATTN: AMSAT-I-MDO, 4300 Goodfellow Blvd., St. Louis, MO 63120-1798. Marine Corps users shall submit SF-368 in accordance with MCO 4855.10 directly to: Commander, Marine Corps Logistics Bases (Code 856), Albany, GA, 31704-5000. We will send you a reply.

1-5. NOMENCLATURE CROSS REFERENCE LIST.

<u>Common Name</u>	<u>Official Nomenclature</u>
Chemical Protective Underwear (CPU)	Underwear, Chemical Protective, Two Piece
Battle Dress Overgarment (BDO) Overgarment (OG84)	Suit, Chemical Protective
Chemical Protective Overgarment (CPOG)	
Saratoga suit	Suit Chemical and Biological Protective, Carbon Sphere

Common Name	Official Nomenclature
Aircrew Uniform, Integrated Battlefield (AUIB)	Coat and Trousers Chemical Protective, Aircrew, Flame Resistant
SCALP	Suit, Contamination Avoidance Liquid Protective
Green Vinyl Overshoes (GVO), or Black Vinyl Overshoes (BVO)	Overshoes, Men's and Women's, Boot, Combat
PASGT Helmet	Helmet, Personal Armor System Ground Troop
CB Gloves	Glove and Glove Set, Chemical Protective

Section II. EQUIPMENT DESCRIPTION

1-6. DESCRIPTION ION OF MAJOR COMPONENTS.

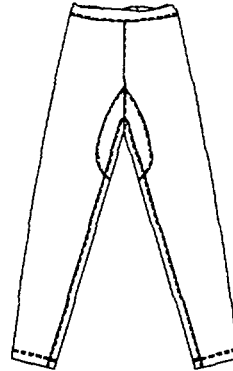

- a. Chemical Protective Underwear. Two-piece (CPU). Chemical protective underwear provide protection when worn under a duty uniform.

TM 10-8415-209-10
TM 8415-10/2

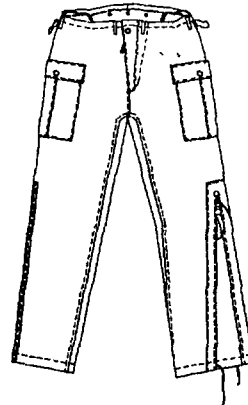
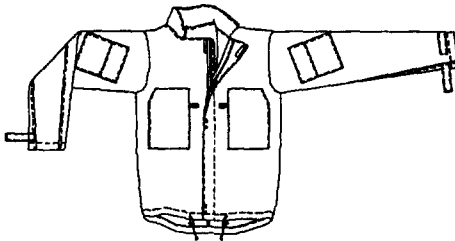

b. Chemical Protective Overgarment. Chemical Protective Overgarment, also called Battle Dress Overgarment (BDO)(OG 84) is a woodland or desert camouflage two piece suit, and a replacement for the olive drab (OD) green CPOG, still in supply system.

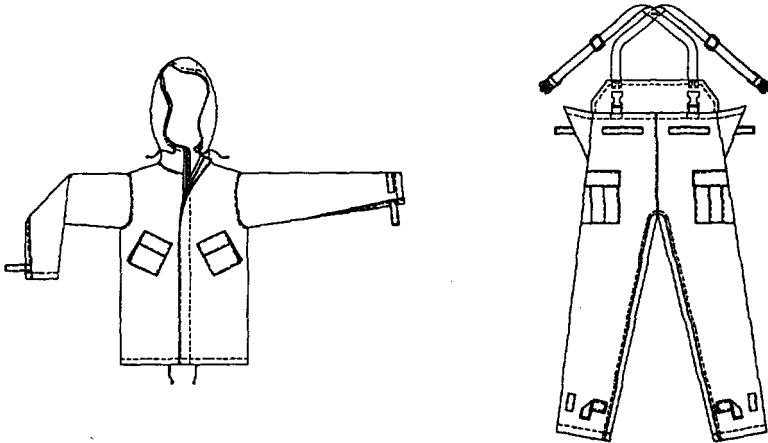

c. Chemical and Biological Protective Suit. Carbon Sphere (Saratoga). The Saratoga suit (Marine Corps use only) provides chemical and biological protection as a mission-specific alternative to the standard BDO. It is a woodland or desert camouflage suit designed to be worn over the normal duty uniform.

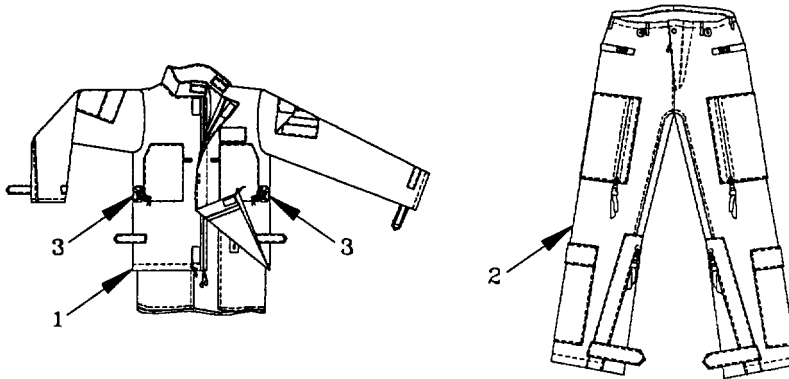

d. Aircrew Uniform Battlefield (AUIB). This coat (1) and trousers (2) combines chemical protection with the flame retardancy of the flyer's coverall into a single duty uniform. It has integrated pass-throughs (3) to accommodate hoses for a microclimate cooling vest which is not yet available for general use. AUIB is issued in tan and woodland camouflage..

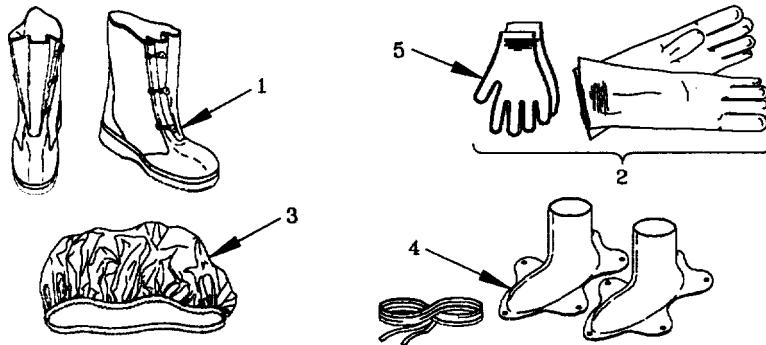

e. Chemical Protective Overshoes, Gloves, and Helmet Cover. Green and Black Vinyl Overshoes (GVOs and BVOs) (1); CB Glove sets (2); and Chemical Protective Helmet Cover (3), are worn with any of the chemical protective clothing ensembles. The GVO, which replaced the Footwear Covers, Chemical Protective (CPFC) (4), is itself being replaced by BVO. Gloves are available in three thicknesses, depending on mission and are worn with cotton liners (5) for comfort.

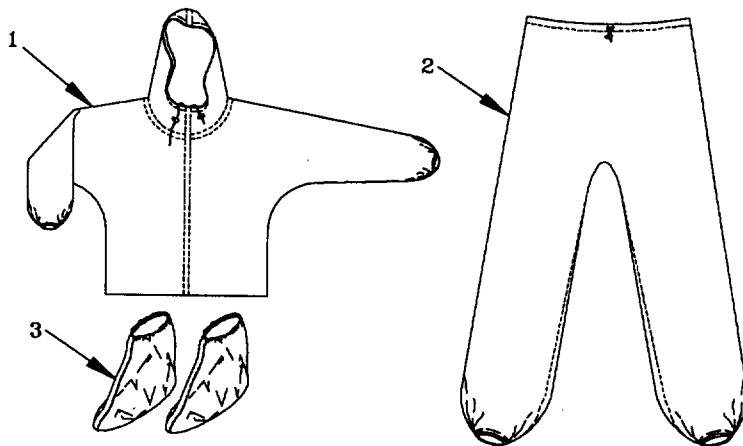

f. Suit, Contamination Avoidance, Liquid Protective (SCALP). The SCALP suit consists of a lightweight, impermeable poncho (1), trousers (2), and footwear covers (3) to be worn over chemical protective clothing. SCALP is desert tan or sage green.

1-7. DIFFERENCES BETWEEN MODELS.

Suit, Chemical Protective CPOG, green*
Class 1 BDO, woodland camouflage
Class 2 BDO, 6 color desert camouflage**
Class 3 BDO, 3 color desert camouflage

Coat and Trousers, Chemical Protective, Aircrew, Flame Resistant
Class 2 Tan
Class 3 Woodland camouflage

Suit, Chemical and Biological Protective, Carbon Sphere
Class 1 Woodland camouflage
Class 2 Desert camouflage

*CPOG will be in service until supplies are exhausted.

**Class 2 is being replaced by Class 3.

Suit, Contamination Avoidance, Liquid Protective

- Class 1 Sage green
- Class 2 Desert tan

Glove Set, Chemical Protective

- Type I 25 Mil thickness
- Type II 14 Mil Thickness
- Type III 7 Mil thickness

Overshoes, Men's and Women's, Boot, Combat

- GVO OD green*
- BVO..... Black

Footwear Covers, Chemical Protective Overshoes (CPFC)**

- 1 Four eyelet
- 2..... Five eyelet

*GVOs will be in service until supplies are exhausted, then BVOs will be issued.

**CPFCs will be in service until supplies are exhausted

Section III. PRINCIPLES OF OPERATION

1-8. GENERAL. The various Individual Chemical Protective Clothing items provide different degrees of protection that can be used to defend against a mission-specific threat Each item also has wear and protection thresholds.

Table 1-1. Mission Oriented Protective Posture (MOPP) Levels

	CPOG or BDO or CPU W/Duty Uniform	Helmet cover	Overboots	Mask/Hood	Gloves
MOPP 0	Carried	Carried	Carried	Carried	Carried
MOPP 1	Worn	Worn	Carried	Carried	Carried
MOPP 2	Worn	Worn	Worn	Carried	Carried
MOPP 3	Worn	Worn	Worn	Worn	Carried
MOPP 4	Worn	Worn	Worn	Worn	Worn

a. Chemical Protective Underwear Two-piece (CPU). The CPU is a two piece undergarment intended to be worn under the standard duty uniform. It provides chemical protection as an alternative to the Battle Dress Overgarment (BDO) in all climatic categories (hot, basic, cold, extreme cold). The CPU is designed to be worn next to skin for up to 15 continuous days, and can be laundered once in its service life (see paragraph 3-2 for laundering procedures). The CPU protection may be degraded by gross contamination with petroleum, oils, lubricants (POLs). The CPU will be issued as individual equipment to certain combat vehicle crewman, aviators, and Special Operations units. Refer to FM 3-4/FMFM 11-9 for protective capabilities.

b. Chemical Protective Suit

(1) *Chemical Protective Overgarment (CPOG)*. The CPOG is an OD green overgarment consisting of a coat and trousers. This suit is normally worn over the duty uniform, however, in high temperatures it may be worn over underwear. In extreme cold weather, the CPOG will be worn under arctic clothing for camouflage.

The CPOG provides protection against chemical agent vapors, liquid droplets; biological agents; toxins; and radioactive alpha and beta particles. The CPOG is not intended to be decontaminated, reimpregnated, or laundered, and should be properly discarded after exposure to chemical agents in accordance with FM 3-5/FMFM 11-10. Contact with petroleum, oils and lubricants (POLs) will significantly degrade protection provided by the CPOG. Refer to FM 3-4/FMFM I 1-9 for protective capabilities.

(2) *Battle Dress Overgarment (BDO)/Overgarment (OG84)*. The BDO is a camouflage overgarment consisting of a coat and trousers. This suit is normally worn over the duty uniform, however, in high temperatures it may be worn over underwear. In extreme cold weather, the BDO will be worn under arctic clothing for camouflage.

The BDO provides protection against chemical agent vapors, liquid droplets; biological agents; toxins; and radioactive alpha and beta particles. The BDO is not intended to be decontaminated, reimpregnated, or laundered, and should be properly discarded after exposure to chemical agents in accordance with FM 3-5/FMFM 11-10. Contact with petroleum, oils and lubricants (POLs) will significantly degrade protection provided by the BDO. The nylon/cotton outer layer is treated with a durable liquid repellent. Whereas it is water resistant, it is not water proof, and protection may be degraded when suit is soaked. Refer to FM 3-4/FMFM 1 1-9 for protective capabilities.

c. Suit, Chemical and Biological Protective, Carbon Sphere (Saratoga). The Saratoga suit is a camouflage (desert and woodland) overgarment consisting of coat and trousers. This suit is normally worn over the duty uniform, however, in high temperatures it may be worn over underwear. In extreme cold weather, the Saratoga suit will be worn under arctic clothing for camouflage.

The Saratoga suit provides protection against chemical agent vapors, liquid droplets; biological agents; toxins; and radioactive alpha and beta particles. It may be laundered up to ten (10) times during its NBC service life. The Saratoga suit is not intended to be decontaminated or reimpregnated, and should be properly discarded after exposure to chemical agents in accordance with FM 3-5/FMFM 11-10. Contact with petroleum, oils and lubricants (POLs) will significantly degrade protection provided by the Saratoga suit. The nylon/cotton outer layer is treated with a durable liquid repellent. Whereas it is water resistant, it is not water proof, and protection may be degraded when suit is soaked. Refer to FM 3-4 FM FM 11-9 for protective capabilities.

The Saratoga suit is presently authorized for Marine Corps use only.

d. Aircrew Uniform, Integrated Battlefield (AUIB). This standard combat uniform replaces use of Nomex suit in combination with CPOG or BDO. This suit is worn as a duty uniform, not an overgarment in hot, basic, cold and extreme cold climatic categories.

The AUIB provides protection against flame; chemical agent vapors, liquid droplets; biological agents; toxins; and radioactive alpha and beta particles. The AUIB is not intended to be decontaminated, reimpregnated, or laundered, and should be properly discarded after exposure to chemical agents in accordance with FM 3-5/FMFM 11-10. Contact with petroleum, oils and lubricants (POLs) will significantly degrade protection provided by the AUIB. Whereas it is water resistant, it is not water proof, and protection may be degraded when suit is soaked. Refer to FM 3-4/FMFM 11-9 for protective capabilities.

e. Suit, Contamination Avoidance, Liquid Protective (SCALP). This impermeable suit consists of a hooded poncho, trousers, and two footwear covers. The footwear cover soles are embossed for enhanced durability and slip resistance. The SCALP, worn over chemical protective clothing, provides protection from gross liquid contamination by chemical agents.

The suit is primarily used by Armor and Explosive Ordnance Disposal (EOD) personnel and personnel in collective protection who may, by necessity, be forced to leave collective protection to perform some vital function. In such a situation, the SCALP reduces reentry time. A secondary use of SCALP is to protect decontamination personnel from becoming contaminated during decontamination operations. The SCALP is not intended to be decontaminated, reimpregnated, or laundered, and should be properly discarded after exposure to chemical agents in accordance with FM 3-5/FMFM 11-10. Refer to FM 3-4/FMFM 11-9 for protective capabilities.

Prior to donning the SCALP, the soldier should first achieve MOPP level 4.

f. Overshoes, Men's and Women's, Boot, Combat (GVOs, BVO.s).

CAUTION

Prolonged contact with Decontamination Solution No. 2 (DS2) will degrade the GVO/BVO.

The GVOs (green) and BVOs (black) are impermeable vinyl overshoes with elastic fasteners. The GVO/BVO worn over the standard leather combat boot protects the wearer against CB agents, radioactive materials, rain, mud or snow. (However, GVOs and BVOs issued and worn for environmental protection should not be used for NBC protection. A new pair should be issued with NBC protective gear.) Refer to FM 3-4/FMFM 11-9 for protective capabilities.

- g. Chemical Protective Footwear Covers (CPFCs).

CAUTION

Prolonged contact with Decontamination Solution No. 2 (DS2) will degrade the CPFCs.

The CPFCs are unsupported, impermeable butyl rubber overshoes and require lacing to support and secure. Refer to EM 3-4/FMFM 11-9 for protective capabilities.

- h. Gloves and Glove Set Chemical Protective.

CAUTION

Prolonged contact with Decontamination Solution No. 2 (DS2) will degrade the chemical protective gloves.

The glove set consists of an outer glove for chemical protection and an inner cotton liner for perspiration absorption. The liners can be worn on either hand. When engaged in heavy work, or when in cold weather, standard leather work gloves or black shells should be worn over the chemical protective gloves. The gloves provide protection from chemical agents, and insect vectors as long as they remain free of damage and/or degradation. Refer to FM 3-4/FMFM 11-9 for protective capabilities.

The gloves are issued in three thicknesses: 7, 14, and 25 mil. The 7 mil glove set is used by soldiers such as medical, teletypists, and electronic repair personnel who require extreme tactility and/or sensitivity and will not expose the gloves to harsh treatment. The 14 mil is used by soldiers such as aviators, vehicle mechanics, and weapon crews who require tactility and sensitivity and will not expose the gloves to harsh treatment. Use of the more durable 25 mil glove is for soldiers who perform close combat tasks and other types of heavy labor.

Exposure of the gloves to DS2, break-free, antiseize compound or other petroleum based products attacks the rubber (gloves become sticky) and degrades their performance. Contact with these materials should be avoided.

i. Chemical Protective Helmet Cover. This cover protects the PASGT helmet from chemical and biological contamination. Refer to FM 3-4/FMFM 11-9 for protective capabilities.

CHAPTER 2
OPERATING INSTRUCTIONS

Chapter Index

Section I. PREVENTIVE MAINTENANCE CHECKS AND SERVICES (PMCS)	2-2
2-1 Introduction to PMCS Table	2-2
Section II. OPERATION UNDER USUAL CONDITIONS	2-8
2-2 Doming the Chemical protective Underwear (CPU)	2-8
2-3 Doffing the Chemical protective Underwear (CPU)	2-14
2-4 Donning the Chemical protective Overgarments (BDO,OG84,CPOG)	2-17
2-5 Doffing the Chemical Protective Overgarments (BDO,OG84,CPOG)	2-23
2-6 Donning the Saratoga Suit	2-27
2-7 Doffing the Saratoga Suit	2-32
2-8 Donning the Aircrew Uniform, Integrated Battlefield (AUIB)	2-36
2-9 Doffing the Aircrew Uniform, Integrated Battlefield (AUIB)	2-44
2-10 Donning Suit, Contamination Avoidance, Liquid Protective (SCALP)	2-48
2-11 Doffing Suit, Contamination Avoidance, Liquid Protective (SCALP)	2-53
2-12 Decals and Instruction Plates	2-56

Section I. PREVENTATIVE MAINTENANCE CHECKS AND SERVICES.

2-1. INTRODUCTION TO PMCS TABLE. Table 2-1 (PMCS Table) has been provided so you can keep your equipment in good operating condition and ready for its primary mission.

a. Warnings and Cautions. Always observe the WARNINGS and CAUTIONS appearing in your PMCS table. WARNINGS and CAUTIONS appear before applicable procedures. You must observe these WARNINGS and CAUTIONS to prevent serious injury to yourself and others or prevent your equipment from being damaged.

b. Explanations of Table Entries.

(1) *Item No. Column.* Numbers in this column are for reference. When completing DA Forms 2404 (Equipment Inspection and Maintenance Worksheet), include the item number for the check/service indicating a fault. Item numbers also appear in the order that you must do your checks and services for intervals listed.

(2) *Interval Column.* This column tells you when you must do the procedure in the procedure column. The BEFORE procedures must be done before you operate or use the equipment for its intended mission. DURING procedures must be done during the time you are operating or using the equipment for its intended mission. AFTER procedures must be done immediately after you have operated or used the equipment. Monthly procedures must be done every 30 days after issue.

(3) *(Location,) Check/Service Column.* This column provides the location and the item to be checked or serviced. The item location is underlined.

(4) *Procedure Column.* This column gives the procedure you must do to check or service the item listed in the Check/Service column to know if the equipment is ready or available for its intended mission or for operation. You must do the procedure at the time specified in the interval column

(5) *Not Fully Mission Capable If: Column.* Information in this column tells you what faults will keep your equipment from being capable of performing its primary mission. If you make check and service Procedures that show faults listed

in this column, do not operate the equipment. Follow standing operating procedures for maintaining the equipment or reporting equipment failure.

Table 2-1. PREVENTATIVE MAINTENANCE CHECKS AND SERVICES

Item No.	Interval	Item to Check/ Service	Procedure	Not Fully Mission Capable If:
1	Monthly	Vapor-barrier bag	Inspect bag for tears, cracks, pinholes of any size. If bag is torn, but visible contents are not cut, torn or contaminated with POLs, reseal bag with duct tape (Appendix D, item 1). If contents are wet, remove from bag air dry, then reseal bag.	Visible contents are cut, torn or contaminated with POLs. Visible contents are wet

Item No.	Interval	Item to Check/ Service	Procedure	Not Fully Mission Capable If:
2	Before During	CPU, CPOG, BDO, OG84, Saratoga, AUIB	Inspect item for POL or moisture. If items are wet, air dry. Check item for any rips, tears, or holes. Check all fasteners and closures for any damage.	Item is contaminated with POLs or is wet. Item has a rip, tear, or hole of any size. Fasteners or closures do not permit proper fit.

Item No.	Interval	Item to Check/ Service	Procedure	Not Fully Mission Capable If:
NOTE				
White powder on boots and gloves is <i>not</i> a sign of deterioration.				
3	Monthly Before During After	GVO, BVO, CPFC	Inspect overshoe for any holes, cuts, tears, cracking. Inspect laces or elastic closures for cuts, tears, fraying or missing items.	Item has any cuts, tears or cracks. Laces or elastic closures cannot secure GVO, BVO, or CPFC.
4	Monthly Before During After	CB Gloves	Inspect butyl gloves for any cracking, holes, cuts, tears, tackiness.	Gloves have any holes, cuts, tears, cracking, tackiness.

Item No.	Interval	Item to Check/ Service	Procedure	Not Fully Mission Capable If:
5	Monthly Before During	Helmet Cover	Inspect helmet cover for any cuts tears or POL spills.	Cover has any cuts, tears or has POL spills.
6	Before	SCALP	Inspect SCALP for holes, cuts, tears; loose or missing seam tape or elastic; broken or loose barrel-lock. If elastic is broken or loose, secure wrist and leg closures with duct tape (Appendix D, item 1).	SCALP has holes, cuts, tears; loose or missing seam tape; broken or loose barrel-lock.

Section II. OPERATING UNDER USUAL CONDITIONS

2-2. DONNING THE CHEMICAL PROTECTIVE UNDERWEAR (CPU).

Table 2-2. Size Prediction Chart for CPU

UNDERSHIRT

Chest Size	Corresponding Shirt Size
31-32.....	32
33-34.....	34
35-36.....	36
37-38.....	38
39-40.....	40
41-42.....	42
43-44.....	44
45-46.....	46
47-48.....	48

Table 2-2. Size Prediction Chart for CPU (Cont'd)

DRAWERS

Waist Size (inches)	Seat Size (inches)	Corresponding Drawer Size
25-26	34	26
27-28	36	28
29-30	38	30
31-32	40	32
33-34	42	34
35-36	44	36
37-38	46	38
39-40	48	40
41 -42	50	42

Notes:

- If individual seat measurement is larger than the size indicated for regular garment, select the next larger seat drawer size.
- Use charts as a guide. Wear the suit that is most form fitting, yet comfortable.

NOTE

Perform PMCS on individual equipment IAW Table 2-1 prior to use

- a. When directed by unit Commander and/or implementing MOPP, don the CPU using the following steps:
 - (1) Unpack CPU and perform PMCS IAW Table 2-1. If any damage is present, exchange item for a new one using designated supply system. Retain containers and packing.
 - (2) Remove combat boots and duty uniform trouser and shirt.

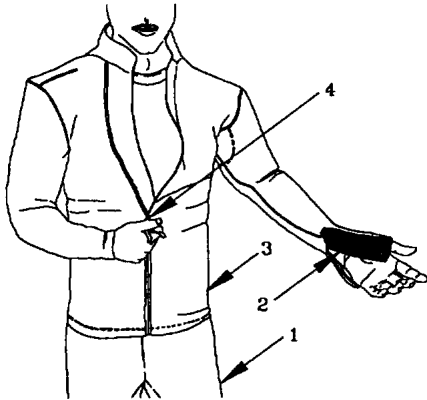

(3) With toes extended, put leg into drawers (1) and pull drawers (1) up. Repeat for other leg.

(4) Undo undershirt sleeve hook and pile fastener tapes (2). Don undershirt (3) and close front slide fastener (4). Pull undershirt (3) down over drawers (1). Fasten sleeve hook and pile fasteners tapes (2).

(5) Don your duty uniform, leaving wrist and ankle closures open.

(6) Don combat boots over undergarment drawers (1).

b. If PASGT helmet is worn, don chemical protective helmet cover.

c. When directed by unit MOPP level, don GVOs, BVOs or CPFCs (1) and blouse duty uniform ankle closures (2) over GVOs, BVOs or CPFCs (1). (When insulated rubber, cold weather boots are worn, chemical protective overboots are not required.)

d. When directed by unit MOPP level, don chemical protective mask and hood (refer to Soldier's Manual STP 211-SMCT or Appendix A for specific chemical protective mask TM).

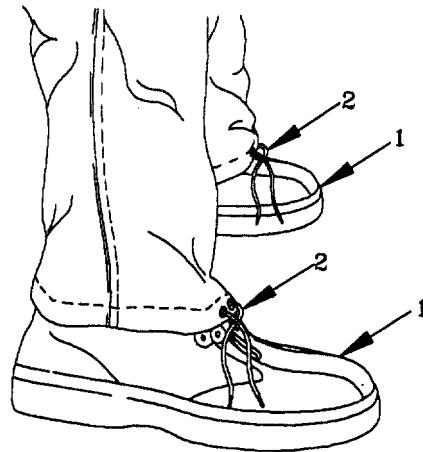

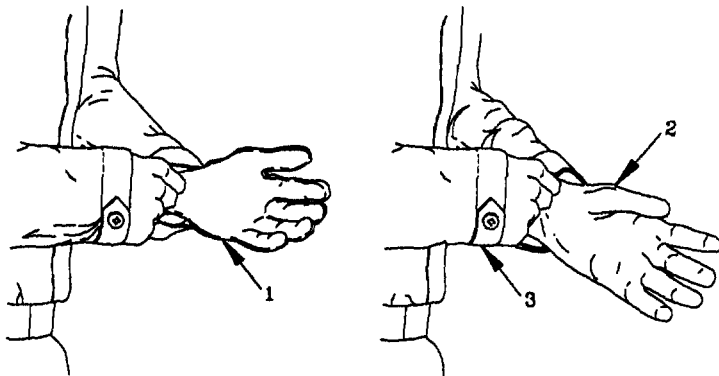

e. When directed by unit MOPP level, don glove liners (1) and chemical protective glove (2). Secure duty uniform wrist closures (3) over chemical protective glove (2) (assistance may be required).

2-3. DOFFING THE CHEMICAL PROTECTIVE UNDERWEAR (CPU).

WARNING

The following doffing procedure is to be used only when you have not been exposed to contamination. For decontamination procedures, see FM 3-5/FMFM 11-10.

- a. General. These procedures should be performed when removing the CPU in an uncontaminated environment. Refer to FM 3-5/FMFM 11-10 for removing clothing items in a contaminated NBC environment.
- b. Perform the following steps:
 - (1) Remove helmet and chemical protective helmet cover, if worn.
 - (2) Remove chemical protective mask and hood (refer to Soldier's Manual STP 21-1-SMCT or Appendix A for specific chemical protective mask TM).

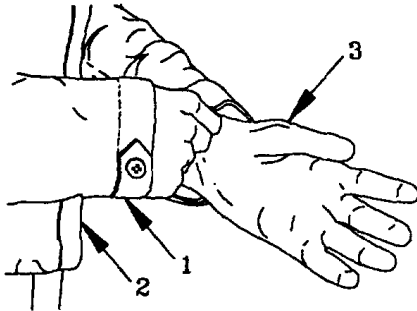

(3) Unfasten wrist closures (1) on duty uniform (2).

(4) Remove CB Gloves (3) and liners.

(5) Unblouse duty uniform ankle closures (1) above GVOs, BVOs, or CPFCs (2).

(6) Remove GVOs, BVOs, or CPFCs (2).

(7) Remove combat boots.

(8) Remove duty uniform.

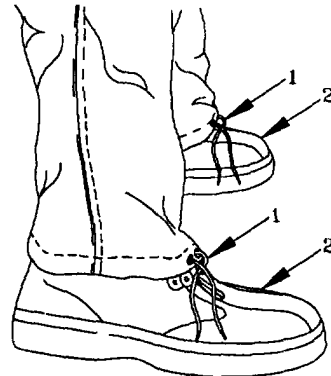

(9) Unfasten sleeve hook and pile (1) fastener tapes and front slide fastener (2) on CPU undershirt (3).

(10) Remove CPU undershirt (3).

(11) Remove CPU drawers (4).

(12) Don duty uniform and combat boots.

(13) Pack and seal CPU in original containers.

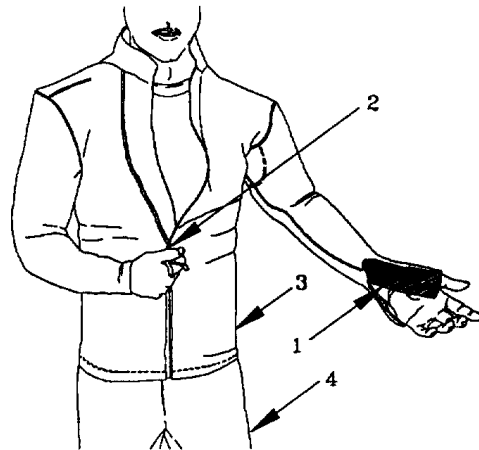

2-4. DONNING THE CHEMICAL PROTECTIVE OVERGARMENTS (BDO, OG84, CPOG).

Table 2-3. Size Prediction Chart for:

Suit, Chemical Protective (BDO OG84, CPOG)

Waist Size	Over underwear	Over duty uniform	Over field coat	Over arctic wear, parka and trousers
23"	XXX-S	XX-S	X-S	S
27"	XX-S	X-S	S	M
31"	X-S	S	M	L
35"	S	M	L	X-L
39"	M	L	X-L	XX-L
43"	L	X-L	XX-L	XX-L

NOTE

Perform PMCS on individual equipment IAW Table 2-1 prior to use.

- a. When directed by unit MOPP, don the overgarment in the following manner

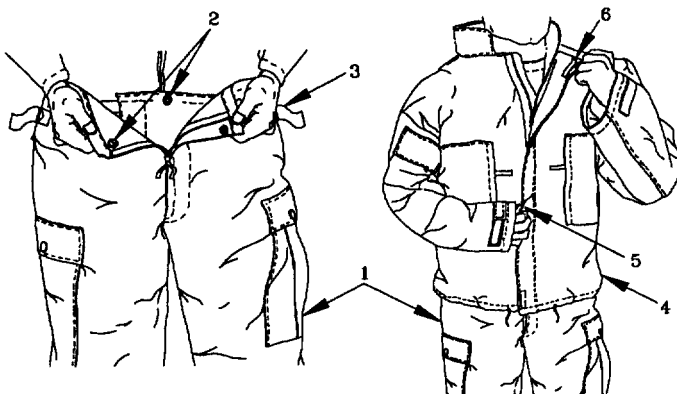

(1) Don duty uniform (when specifically authorized, the BDO/CPOG is the duty uniform). Tuck trouser cuff of duty uniform, if worn, into combat boots and lace for a comfortable fit.

(2) After selecting proper size, open vapor-barrier bag, remove overgarment and perform PMCS IAW Table 2-1: If damaged, exchange item for a new one using designated supply system Retain containers an" packing

(3) Don overgarment trousers (1) over normal duty uniform (or underwear in hot climate).

(4) Close the fly, fasten two fly opening snaps (2), and adjust waistband tabs (3) for snug fit.

(5) Don overgarment jacket (4), close front slide fastener (5) and secure three hook and pile fasteners tapes on front flap (6). The front slide fastener may be left partially open for comfort until unit MOPP directs it be closed.

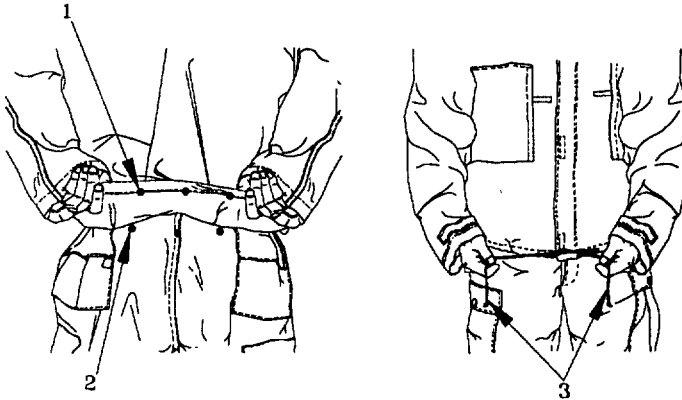

(6) Fasten three snaps in rear of jacket (1) to three snaps on overgarment trousers (2).

(7) Adjust and tie jacket waist drawcord (3) for snug fit to minimize bellowing action that may draw contaminants into suit.

b. If PASGT helmet is worn, don chemical Protective helmet cover.

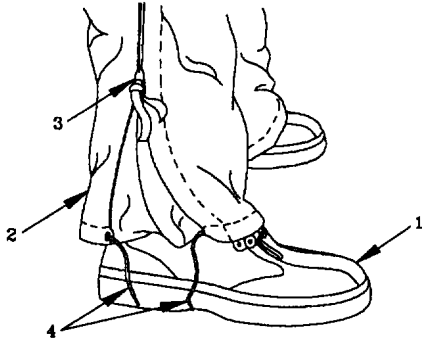

c. When directed by unit MOPP, don GVOs, BVOs, or CPFCs (1) over combat boot. (When insulated rubber, cold weather boots are worn, chemical protective overboots are not required.)

(1) Button or lace GVOs, BVOs, or CPFCs (1).

(2) Blouse overgarment trouser legs (2) over chemical protective overshoes (1). Close trouser leg slide fastener (3) and snug and tie drawcords (4). In hot weather, the leg may remain loose for comfort until unit MOPP directs that it be secured.

d. When directed by unit MOPP, don protective mask and hood (refer to Soldier's Manual STP 21-1-SMCT or Appendix A for specific chemical protective mask TM).

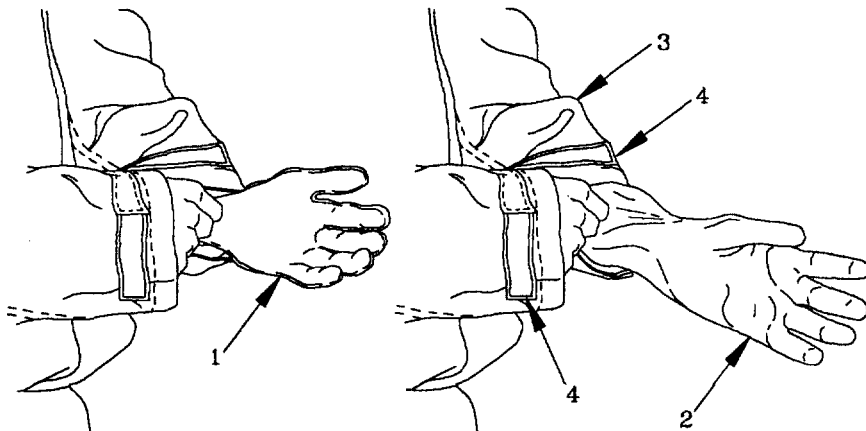

e. When directed by unit MOPP, don glove liners and chemical protective gloves as follows:

(1) Don glove liners (1). Don chemical protective gloves (2) over liners (1).

(2) Place cuffs of overgarment jacket (3) over chemical protective gloves (2) and secure hook and pile fastener tapes (4) for snug fit.

2-5. DOFFING THE CHEMICAL PROTECTIVE OVERGARMENTS (BDO/OG84/CPOG).

WARNING

The following doffing procedure is to be used only when you have not been exposed to contamination. For decontamination procedures, see FM 3-5/FMFM 11-10.

a. General. These procedures should be followed when removing the overgarment suit in an uncontaminated environment. To remove the overgarment suit in a contaminated environment, refer to FM 3-5/FMFM 11-10.

b. Perform the following steps.

(1) Remove helmet and chemical protective helmet cover, if worn.

(2) Remove chemical protective mask and hood (refer to Soldier's Manual STP 21-1-SMCT or Appendix A for specific chemical protective mask TM).

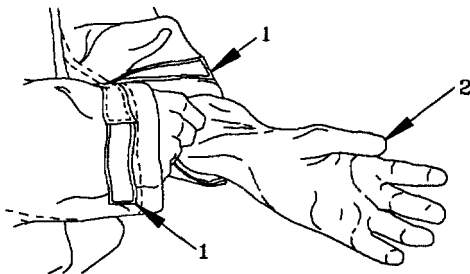

- (3) Unfasten the hook and pile fastener tapes (1) at wrist of overgarment
- (4) Remove chemical protective gloves (2) and liners.

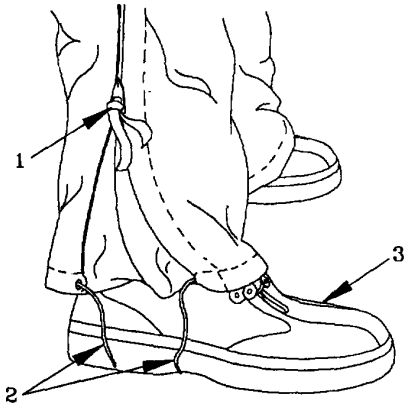

- (5) Open trouser leg slide fasteners (1) and drawcords (2) on overgarment
- (6) Remove your GVOs, BVOs, or CPFCs (3).



(7) Untie overgarment jacket drawcords (1), open front flap (2) and open slide fastener (3). Unfasten three snaps (4) in rear of overgarment jacket (5).

(8) Remove jacket (5).

(9) Unfasten snaps (6), open fly slide fastener (7), and remove trousers (8).

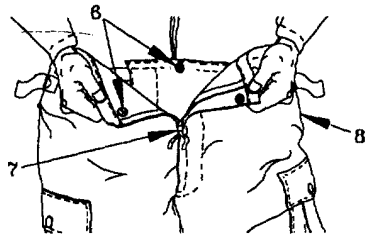
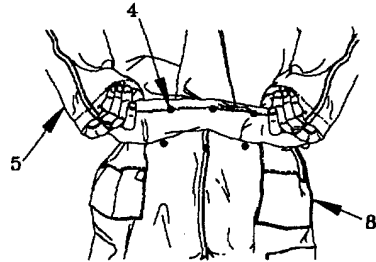

(10) Pack and seal overgarment in containers.

2-6. DONNING THE SUIT, CHEMICAL AND BIOLOGICAL PROTECTIVE CARBON SPHERE (SARATOGA).

Table 2-4. Size Prediction Chart for Saratoga Suit

Saratoga Size	Height	Chest
S	5'3"	36
M	5'7"	39"
L	5'11"	39"
XL	6'3"	42"

NOTE

Perform PMCS on individual equipment IAW Table 2-1 prior to use.

- a. When directed by unit MOPP, don the overgarment in the following manner:

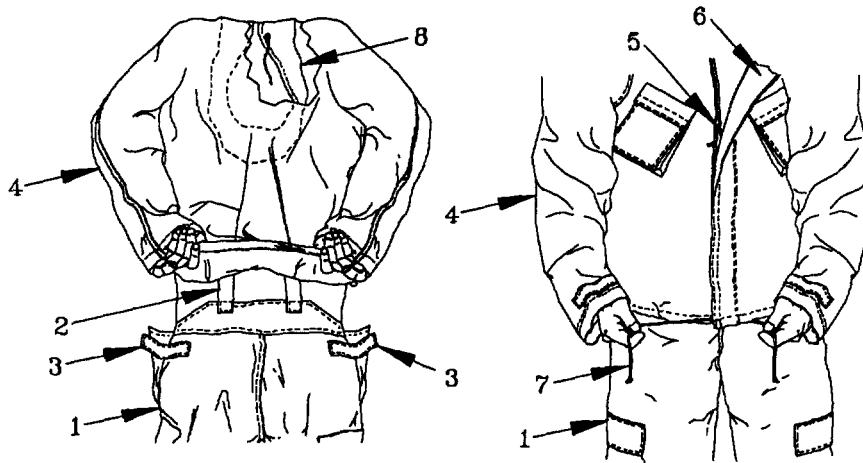

(1) Don duty uniform (when specifically authorized, the Saratoga suit is the duty uniform). Tuck trouser cuff of duty uniform, if worn, into combat boots and lace for a comfortable fit.

(2) After selecting proper size, open vapor-barrier bag, remove Saratoga suit and perform PMCS IAW Table 2-1; If damaged, exchange item for a new one using designated supply system Retain containers and packing.

(3) Don overgarment trousers (1) over normal duty uniform (or underwear in hot climate).

(4) Fasten and adjust suspenders (2), then fasten waist band hook and pile tapes (3).

(5) Fold jacket hood (8) to inside of overgarment jacket (4).

(6) Don overgarment jacket (4), close front slice fastener (5) and secure hook and pile fastener tape on front flap (6). The front slide fastener may be left partially open for comfort until unit MOPP directs it be closed.

(7) Adjust and be overgarment jacket waist drawcord (7) for snug fit to

b. If PASGT helmet is worn don chemical protective helmet cover.

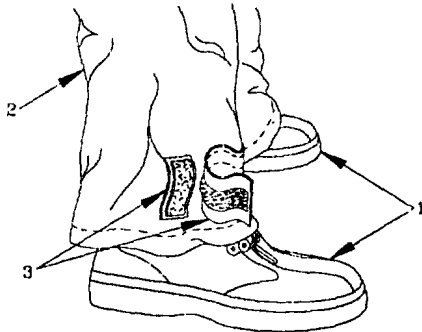

c. When directed by unit MOPP, don GVOs, BVOs, or CPFs (1) over combat boot. (When insulated rubber, cold weather boots are worn, chemical protective overboots are not required)

(1) Button or lace GVOs, BVOs, or CPFs (1).

(2) Blouse overgarment trouser legs (2) over GVOs, BVOs, or CPFs(1). Snug and fasten hook and pile fastener tapes (3). In hot weather, the leg may

remain loose for comfort until unit MOPP directs that it be secured.

d. When directed by unit MOPP, don protective mask (refer to Soldier's Manual STP 21-1-SMCT or Appendix A for specific chemical protective mask TM).

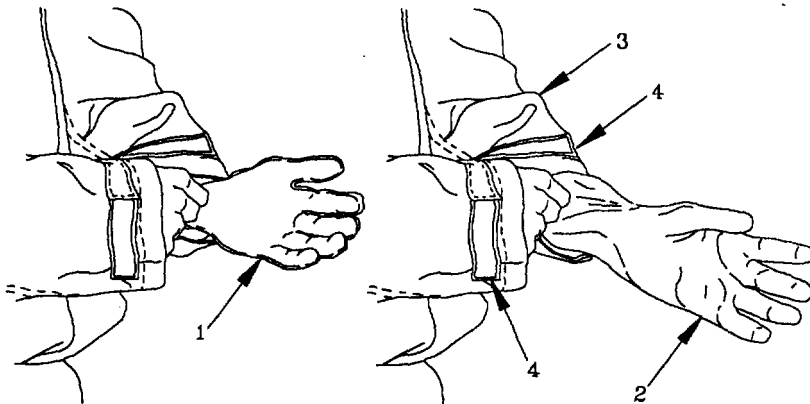

e. When directed by unit MOPP, don glove liners and chemical protective gloves as follows:

(1) Don glove liners (1). Don chemical protective gloves (2) over liners (1).

(2) Place cuffs of overgarment jacket (3) over chemical protective gloves (2) and secure hook and pile fastener tapes (4) for snug fit.

2-7. DOFFING THE SUIT, CHEMICAL AND BIOLOGICAL PROTECTIVE, CARBON SPHERE (SARATOGA).

WARNING

The following doffing procedure is to be used only when you have not been exposed to contamination. For decontamination procedures see FM 3-5/FMFM 11-10.

a. General. These procedures should be followed when removing the overgarment suit in an uncontaminated environment. To remove the overgarment suit in contaminated environment, refer to FM 3-5/FMFM 11-10.

b. Perform the following steps.

(1) Remove helmet and chemical protective helmet cover, if worn.

(2) Remove chemical protective mask (refer to Soldier's Manual STP 21-1-SMCT or Appendix A for specific chemical protective mask TM).

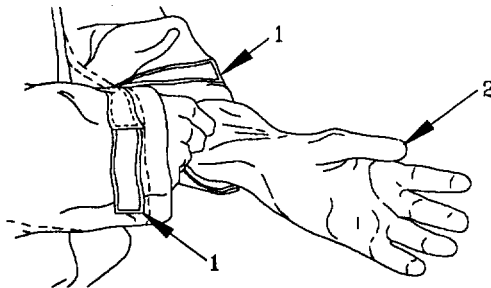

- (3) Unfasten the hook and pile fastener tapes (1) at wrist of overgarment jacket.
 - (4) Remove chemical protective gloves (2) and liners.
 - (5) Unfasten hook and pile fastener tapes (1) on overgarment trouser leg (2).
 - (6) Remove your GVOs, BVOs, or CPFCs
- (3).

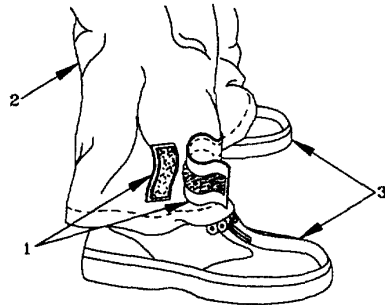

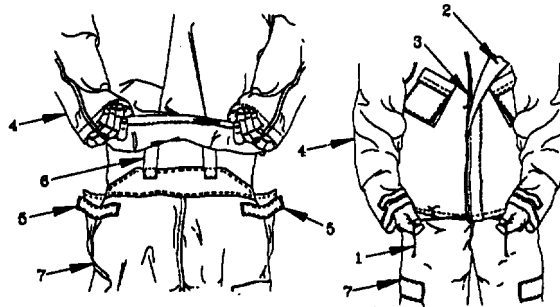

- (7) Untie overgarment jacket drawcords (1), open front flap (2) and open slide fastener (3).
- (8) Remove jacket (4).
- (9) Unfasten waist hook and pile tapes (5), unfasten suspenders (6), and remove trousers (7).
- (10) Pack and seal Saratoga suit in containers.

2-8. DONNING THE AIRCREW UNIFORM, INTEGRATED BATTLEFIELD (AUIB)

Table 2-5. Schedule of Sizes for AUIB

COAT:

	<u>X-Short</u>	<u>Short</u>	<u>Regular</u>	<u>Long</u>
X-Small	X	X	-	-
Small	X	X	X	X
Medium	X	X	X	X
Large	-	X	X	X
X-Large	-	-	X	X

TROUSERS:

	<u>X-Short</u>	<u>Short</u>	<u>Regular</u>	<u>Long</u>
X-Small	-	X	-	-
Small	X	X	X	X
Medium	X	X	X	X
Large	-	X	X	X
X-Large	-	X	X	X

Table 24. Size Prediction Chart for AUIB Coat

Chest Size	Height			
	Up to 63"	63" to 67"	67" to 70"	71" to 74"
Up to 33"	X-Small X-Short	X-Small Short	X-Small Regular	-
33" to 37"	Small/ X-Short	Small/ Short	Small/ Regular	Small/ Long
37" to 40"	Medium/ X-Short	Medium Short	Medium/ Regular	Medium/ Long
41" to 44"	-	Large/ Short	Large/ Regular	Large/ Long
45" to 48"	-	-	X-Large/ Regular	X-Large Long

Table 2-7. Size Prediction Chart for AUIB Trousers

Waist Size	Inseam			
	24 1/2" 26 1/2"	27 1/2" to 29 1/2"	30 1/2" to 32 1/2"	33 1/2" to 35 1/2"
24" to 27"		X-Small/ Short		
28" to 31"	Small/ X-Short	Small/ Short	Small/ Regular	Small/ Long
32" to 35"	Medium/ X-Short	Medium/ Short	Medium/ Regular	Medium/ Long
36" to 39"	-	Large/ Short	Large/ Regular	Large/ Long
40" to 43"	-	X-Large/ Short	X-Large/ Regular	X-Large/ Lone

a. General. The AUIB is sized similar to the CWU-27/P flier's coverall. The coat and trousers are a duty uniform, not an overgarment. The main difference in sizing is that the coat has a larger chest. In addition, the coat and trousers are sized adjectively (small, medium, large) as opposed to numerically (38, 40, 42). Use the size prediction chart as a guide to determine your approximate coat and trouser size. If your chest size or waist size falls between two sizes, you should go to the larger size. This is a general rule. The coat and trouser will not fit as snugly as the CWU-271P fliers coverall. Wear the size that is most comfortable.

NOTE

Perform PMCS on individual equipment IAW Table 2-1 prior to use.

b. Open vapor-barrier bags containing AUIB coat and trouser and perform PMCS IAW Table 2-1. If any damage exists, exchange item for a new one using designated supply System Retain containers and packing.

c. Turn integrated pass-throughs (1) inside AUIB coat (2), pull drawcord (3) tight, wrap around cone (1), and adjust barrel lock (4).

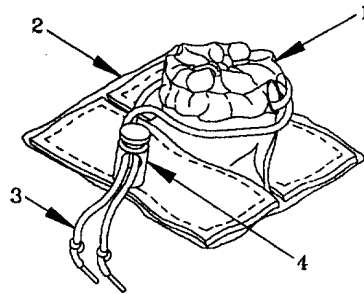
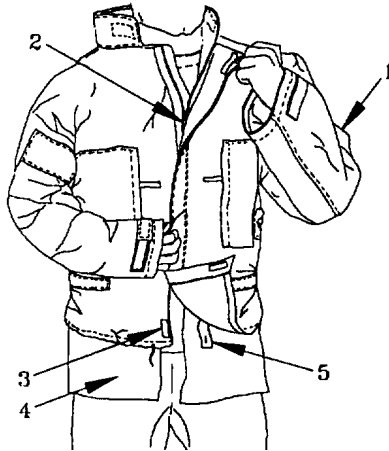

d. Don AUIB coat (1) and engage front slide fastener (2) about threequarters.

e. Fasten lower two hook and pile fastener tapes (3), then turn bottom of coat up to expose interior curtain (4) and elastic button hole tabs (5).

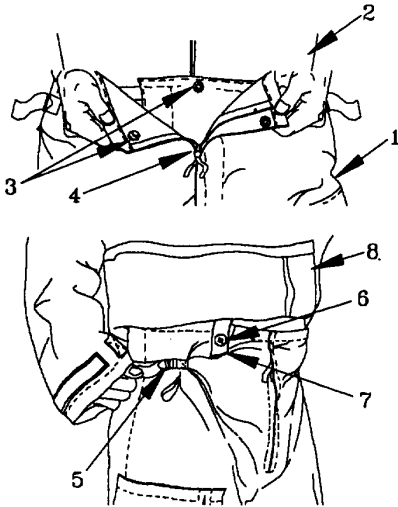

f. Don AUIB trousers (1) and pull up over curtain (2).

g. Close fly snap fasteners (3) (interior and exterior) and close slide fastener (4)

h. Pull the trousers up until the buckle and tape waist adjustment straps (5) are above the hip bone, and pull to tighten.

i. Button the elastic tape fasteners (7) to the trouser buttons (6).

j. Roll bottom of coat (8) down over trousers.

- k. Pull elastic drawcords (1) in bottom hem of coat and adjust barrel locks (2).
- l. Adjust coat waist hook and pile fastener tapes (3) on each side of coat.
- m. Close slide fastener (4) on coat. Close hook and pile fastener tapes (5) over slide fastener to seal.
- n. Close neck hook and pile fastener tape (6).
- o. Don combat boots.

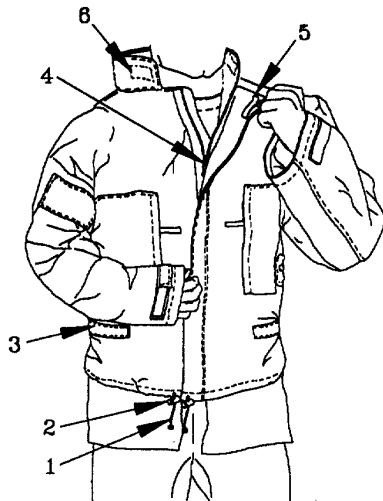

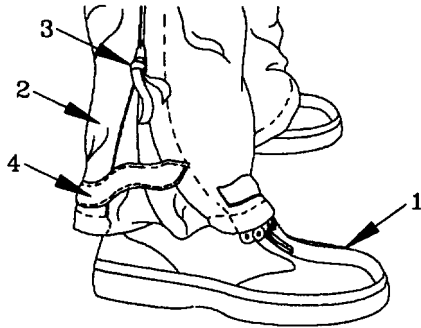

p. Don GVOs, BVOs, or CPFCs (1) and blouse trouser leg (2) over GVOs, BVOs, or CPFCs (1).

q. Close leg slide fastener (3) and fasten hook and pile fastener tapes (4).

r. Don Nomex flight gloves (5).

s. Don chemical protective gloves (6) over Nomex flight gloves (5).

t. Pull cuffs (7) over gloves (S), then adjust wrist hook and pile fastener tapes (8).

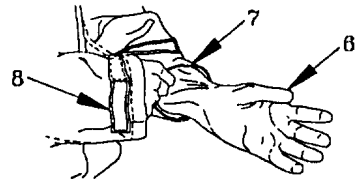
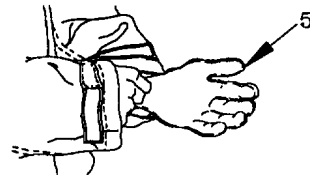

2-9. DOFFING THE AIRCREW UNIFORM, INTEGRATED BATTLEFIELD (AUIB)

WARNING

The following doffing procedure is to be used only when you have not been exposed to contamination. For decontamination procedures, see FM 3-5/FMFM 11-10.

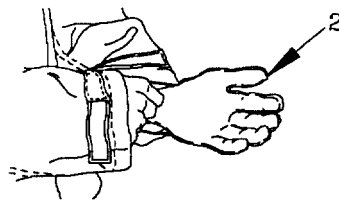
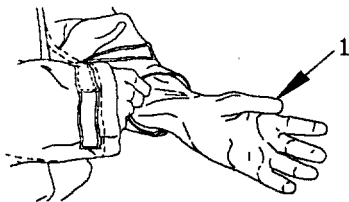

- a. Remove chemical protective gloves (1) and Nomex flight gloves (2).

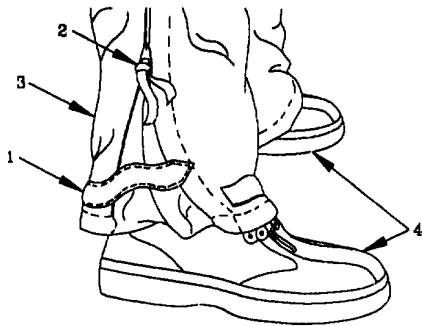

- b. Open hook and pile fastener tape (1) and slide fastener (2) on each trouser leg (3).

- c. Remove GVOs, BVOs, or CPFCs (4)

- d. Open neck hook and pile fastener tape (1).
- e. Release barrel locks (2) on waist drawcord.
- f. Open front slide fastener (3).
- g. Unbutton elastic tape fasteners (4) from trouser buttons (5).
- h. Remove AUIB jacket (6).

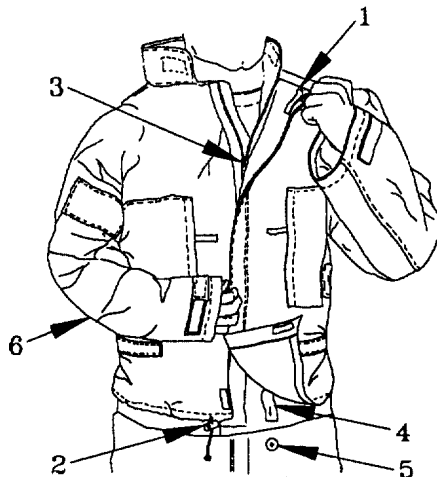

- i. Release waist adjustment straps(1).
- j. Unsnap fly snap fasteners (2) and open fly slide fastener (3).
- k. Remove AUIB trousers (4).
- l. Pack and seal AUIB in containers.

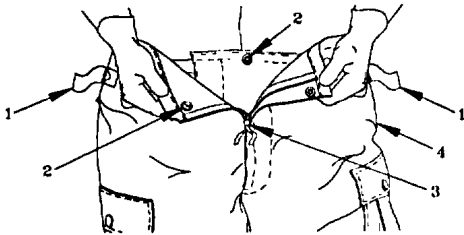

2-10. DONNING SUIT, CONTAMINATION AVOIDANCE, LIQUID PROTECTIVE (SCALP).

Table 2-8. Size Prediction Chart for:
 SCALP Poncho and Trousers

Waist Size	CPOG, BDO OG84 over underwear	CPOG, BDO OG84 over duty uniform	CPOG, BDO OG84 over field coat over duty uniform	CPOG, BDO OG84 over arctic wear, parka and trousers
Up to 23"	S	S	S	S
23"-27"	S	S	S	M/L
27"-31"	S	S	M/L	M/L
31"-35"	S	M/L	M/L	X-L/XX-L
35"-39"	M/L	M/L	X-L/XX-L	X-L/XX-L
39"-43"	M/L	X-L/XX-L	X-L/XX-L	X-L/XX-L

Table 2-9. Size Prediction Chart for:
SCALP Footwear Covers

Combat boot size	SCALP footwear cover size
Up to 8	S
8 to 11	M
Above 11	L

CAUTION

Use care when donning not to tear suit. Damage to suit will reduce the protective capabilities.

NOTE

Perform PMCS on individual equipment IAW Table 2-1 prior to use.

- a. Don chemical protective clothing to attain MOPP level 2.
- b. Unpack the proper size SCALP footwear covers, poncho and trousers and perform PMCS IAW Table 2-1. If damaged or incorrectly sized, exchange for a new one using designated supply system. Retain containers and packing.

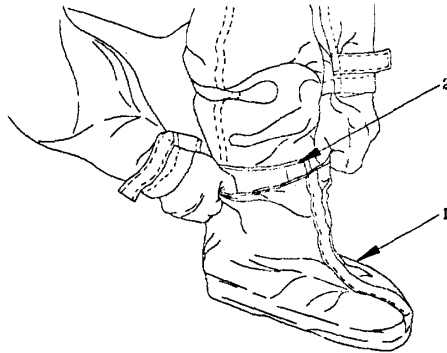

- c. Place SCALP footwear covers (1) over GVOs, BVOs, or CPFCs (2) and pull up past ankles

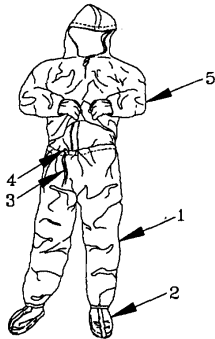

- d. Don SCALP trousers (1) and pull them up as far as possible, but make sure trouser leg overlaps top of footwear cover (2). Hold waist drawcord (3) out from your body, and draw barrel lock (4) towards you to tighten.

- e. Don chemical protective mask (refer to Soldier's Manual STP 21-ISMCT or Appendix A for specific chemical protective mask TM).

- f. Don SCALP poncho (5) by placing arms into sleeves, and pulling down over head and top of SCALP trousers (1).

g. Fit poncho hood (1) around protective mask eyepieces and filter inlets. Pull ends of drawcord (2) away and slide barrel locks (3) toward you to tighten. Make sure hood opening remains fitted around eyepieces and filter inlets.

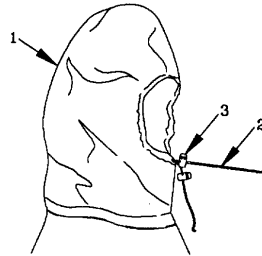
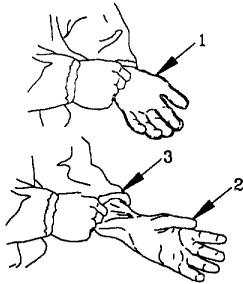

h. Don glove liners (1) and chemical protective gloves (2), and tuck them under sleeves of CPOG, BDO, OG84, or Saratoga (3). If CPU is used, tuck gloves between CPU and duty uniform (3).

2-11. DOFFING THE SUIT, CONTAMINATION AVOIDANCE, LIQUID PROTECTIVE (SCALP).

WARNING

The following doffing procedure is to be used only when you have not been exposed to contamination. For decontamination procedures, see FM 3-5.

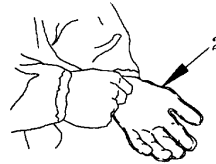
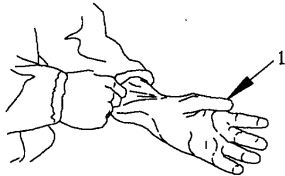

- a. Remove chemical protective gloves (1) and glove liners (2).
- b. Loosen poncho hood barrel locks (1) ;
and drawcords (2), and remove SCALP poncho (3).
- c. Remove chemical protective mask
(refer to Soldier's Manual STP 21-1SMCT or Appendix A for
specific chemical protective mask TM).

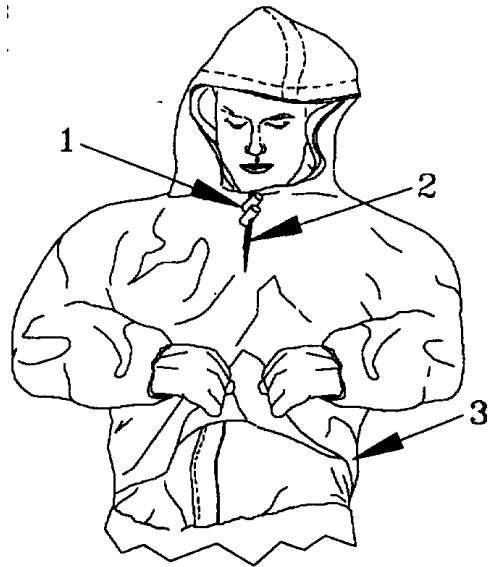

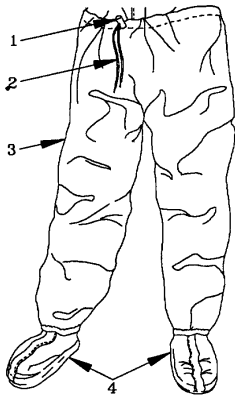

d. Loosen waist barrel lock (1) and drawcord (2), and remove SCALP trousers (3).

e. Remove SCALP footwear covers (4).

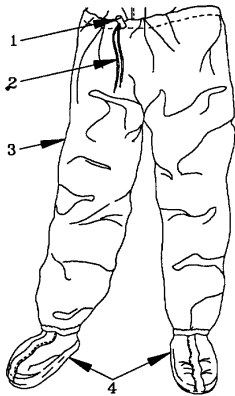

d. Loosen waist barrel lock (1) and drawcord (2), and remove SCALP trousers (3).

e. Remove SCALP footwear covers (4).

2-12. **DECALS AND INSTRUCTION PLATES.** The following labels correspond to the various Individual Chemical Protective Clothing items.

a. Chemical Protective Underwear (CPU).

(1) *Undershirt.*

SIZE 42
8420-01 -F01 -0158
SHIRT, CHEMICAL PROTECTIVE
DAAK60-9 1 -C-007 1
VOLUNTEER APPAREL NC.

a. Field Laundry: The Chemical Protective undergarment shall be laundered utilizing Formula of FM 10-280

Drying: Tumble dry - Do not exceed 120°F. Remove immediately from tier, dryer

b. Machine/Hand Laundering:

Use permanent press was cycle or hand wash using warm water (90-110°F) and mild foundry detergent (non-phosphate). DQ

NOT STARCH!

BEACH/DRY CLEAN Drying: Tumble dry at low temperature (110-120 f) and remove immediately from dryer. To drip dry, remove from water and place on, rust proof hanger.

(2) *Drawers.*

SIZE 34
8420-01 -F01 -0166
DRAWERS, CHEMICAL
PROTECTIVE
DAAK60-91 -C-007 1

VOLUNTEER APPAREL, INC.

c. Field Laundry: The Chemical Protective undergarment strolls be founded utilizing Formula II of FM 10-280

Drying: Tumble dry - Do not exceed 120°F. Remove immediately from the dryer

b. Machine/Hand Laundering Use permanent press wash cycle, or hand wash using warm water (90 -110°F) and mild laundry detergent (non-phosphate).

DO NOT STARCH/BLEACH/DRY CLEAN

Drying: Tumble dry at low temperature (110-120°F) and remove immediately from dryer. To drip dry, remove from water and place on rust proof hanger

b. Chemical Protective Overgarments (BDO).

(1) *Coat.*

MEDIUM
8415-01-137-1704
SUIT, CHEMICAL PROTECTIVE,
CLASS 1
DLA00-90-C-0579
GIBRALTAR, P.R., INC.

1. Wear as outer garment over a/ clothing for protection against chemical agents. Should not be worn with underwear only except in very hot environment.
 2. The multisize system permits the Medium to be worn over the X-Small cold-dry uniform, the Small cold-wet uniform or the Medium hot weather uniform or by the Large person when only the underwear is worn.
- For Coat
3. CAUTION: Before entering the water, when wearing the Chemical Protective Suit, the slide fastener should be opened and the bottom untied. This action will minimize accumulation of water between overgarment and the body.
 - 3a. CAUTION: Protection provided by the overgarment is completely degraded in the areas where the overgarment is wet through with fuel, oil or hydraulic fluid.
 4. This suit is not launderable. It may only be foundered for training purposes.

DO NOT REMOVE THIS LABEL
PI-PIIPI-270492

(2) *Trousers.*

MEDIUM
8415-01-137-1704
SUIT CHEMICAL PROTECTIVE
CLASS 1
DLA100-90-C-0579
GIBRALTAR, P.R., INC.

1. Wear as outer garment layer of clothing for protection against chemical agents. Should not be worn with underwear only, except in very hot environment.
 2. The multisize system permits the Medium to be worn over the X-Small cold-dry uniform, the Small cold-wet uniform or the Medium hot weather uniform or by the Large person when only the underwear is worn.
- For Trousers
3. CAUTION: Before entering the water, when wearing the Chemical Protective Suit, the bottoms of the trouser legs should be untied and slide fasteners opened. This action will minimize accumulation of water between the suit and the body.
 - 3a. CAUTION: Protection provided by the overgarment is completely degraded in the areas where the overgarment is wet through with fuel, oil or hydraulic fluid.
 4. Use suspenders, if required, for improved suspension.
 5. In most circumstances conditions will permit you to remove your footwear prior to donning or doffing these trousers. However in some conditions of chemical warfare it will be necessary to don and doff your trousers without removal of this footwear in this event, care must be taken.
 6. Inspect your leg closure system to insure it is free from dirt and ice, cord is firmly compressed to provide adequate closure.
 7. This suit is not launderable. It may only be laundered for training purposes.

DO NOT REMOVE THIS LABEL
PI-PIPI-270492

c. Suit, Chemical and Biological Protective, Carbon Sphere (Saratoga).

MEDIUM

8415-01 -333-7578

CHEMICAL AND BIOLOGICAL PROTECTIVE SUIT (CARBON SPHERE)

CONTRACT: Ad-67354-90-0318

CONTRACTOR: TEX SHIELD. INC.

MANUFACTURER: CHOCTAW MFG CO., INC.

1. Wear as outer garment layer of clashing for protection against chemical agents.
2. The multisize system permits the size medium to be worn by an individual with height/chest measurements of 5'7"/39"
3. WARNING. IMPORTANT RECORD NUMBER OF LAUNDERINGS MACHINE LAUNDRER DELICATE CYCLE ONLY, WARM WATER, TUMBLE DRY, PERMANENT PRESS OR AIR SETTING.
4. Launder with slide fasteners and hook and pile fasteners closed. Do not press garment. For thorough cleaning, return unit for machine washing in accordance with established laundry procedures. (DELICATE CYCLE < WARM WATER). Suits may be hand laundered using mild soap and warm water. All soap should be thoroughly rinsed out.
6. Do not starch or bleach.
7. DO NOT REMOVE THIS LABEL

Saratoga jacket and trousers have same label.

d. Aircrew Uniform Integrated Battlefield (AUIB)

(1) *Coat.*

MEDIUM
8415-01 -326-2637
COAT, CHEMICAL PROTECTIVE,
AIRCREW, FLAME RESISTANT, CLASS 2
DLA100-9 1 -C-0387
ISRATEX, INC.

1. The coat and trousers are to be worn as a duty uniform in place of the standard aramid flightsuit and chemical protective overgarment when chemical protection is required.
2. The coat and trousers are not launderable. They may only be laundered for training purposes.
3. Protection provided by this coat and trousers may be degraded by gross contamination with fuel, oil or hydraulic fluid.

DO NOT REMOVE THIS LABEL

(2) *Trousers.*

MEDIUM
8415-01 -326-2651
TROUSERS, CHEMICAL PROTECTIVE,
AIRCREW, FLAME RESISTANT. CLASS 2
DLA100-9 1 -C -0387
ISRATEX, INC.

1. The coot and trousers are to be worn as a duty uniform in place of the standard aramid flightsuit and chemical protective overgarment when chemical protection is required.
2. The coot and trousers are not launderable. They may only be laundered for training purposes.
3. Protection provided by this coot and trousers may be degraded by gross contamination with fuel, oil or hydraulic fluid.

DO NOT REMOVE THIS LABEL

CHAPTER 3 OPERATOR MAINTENANCE INSTRUCTIONS

3-1. **GENERAL.** None of the Chemical Protective Clothing Items have any repair maintenance associated with them. If any of your items are damaged or defective, exchange it for a new one using designated supply system.

3-2. **LAUNDERING THE CHEMICAL PROTECTIVE UNDERWEAR (CPU).**

- a. General. The CPU may be laundered once during its NBC service life.
- b. Machine/Hand Laundering.

CAUTION

Do NOT use bleach or starch on CPU. Never press or dry clean CPU. Chemical protection of the CPU will be degraded.

Use formula II from FM 10-280 using warm water (90 F/32° C) and type II detergent (Appendix D items 2 and 3). Rinse thoroughly in clean warm water

OPERATION	WATER LEVEL	TIME (MIN)	TEMPERATURE F/C	SUPPLIES
Suds	High	5	90° / 32°	Detergent, type II, 6 oz.
Suds	High	5	90° / 32°	
Rinse	High	5	90° / 32°	Sour, 2 oz.
Rinse	High	5	90° / 32°	
Rinse	High	5	90° / 32°	

c. Drying. Tumble dry at low temperatures (110°-120° F/43°-49° C) and remove immediately from dryer. AVOID OVER DRYING. To drip dry, remove from water and place on rust-proof hanger.

3-3. LAUNDERING THE SARATOGA SUIT

- a. General. The Saratoga suit may be laundered up to ten (10) times in its NBC service life.
- b. Machine/Hand Laundering Procedure.

CAUTION

- To avoid degrading the chemical protection provided by the Saratoga suit, use only laundering supplies identified in this procedure.
- Do NOT use bleach or starch on Saratoga suit. Never press or dry clean Saratoga suit. Chemical protection of the Saratoga suit will be degraded.

Use powder detergent, Appendix D, item 4, or laundry soap, powder, Appendix D, item 5, and sour-softener, Appendix D, item 6. Use the following sequence:

OPERATION	WATER LEVEL	TIME (MIN)	TEMPERATURE F/C	SUPPLIES
Wash	high	4 - 6	90°-105°F/ 32°-41°C	Detergent
Drain				
Wash	high	2	90°-105°F/ 32°-41°C	Detergent
Drain				
Rinse	high	2	90°-105°F/ 32°-41°C	
Drain	high			
Rinse				
Drain	high			
Rinse			90°-105°F/ 32°-41°C	Sour-softener

OPERATION	WATER LEVEL	TIME (MIN)	TEMPERATURE F/C	SUPPLIES
Drain	high	4 - 6	90°-105°F/ 32°-41°C	Detergent
High speed extract		4 - 6		

c Drying. Tumble dry, 120° F/49°C (max) and remove immediately from dryer. AVOID OVER DRYING. To drip dry, remove from water and place on rust-proof hanger.

**APPENDIX A
REFERENCES**

A-1. SCOPE. This appendix lists all forms, military specifications, field manuals, and technical manuals referenced in this manual.

FORMS

Equipment Inspection and Maintenance Worksheet	DA Form 2404
Improvements to Technical Publications	NAVMC 10772
Product Quality Deficiency Report	SF-368
Recommended Changes to Publications.....	DA Form 2028
Recommended Changes to Equipment Technical Manuals	DA Form 2028-2

FIELD MANUALS

NBC Contamination Avoidance.....	FM 3-3/NAVFAC P-462
NBC Protection	FM 3-4/FMFM 11-9
NBC Decontamination.....	FM 3-5/FMFM 11-10
NBC Operations.....	FM 3-100/FMFM 11-2

TM 10-8415-209-10
TM 8415-10/2

Mobile Field Laundry Clothing Exchange and Bath Operations	FM 10-280
TRAINING PUBLICATIONS (STPs)	
Soldier's Manual of Common Tasks PAMPHLETS	STP21-1-SMCT
PAMPHLETS	
The Army Maintenance Management System (TAMMS)/	
Maintenance Management Update.....	DA PAM 738-750
TECHNICAL MANUALS	
Destruction of Army Materiel to Prevent Enemy Use	TM 750-244-3
Operator's Manual for Mask, Chemical-Biological:	
Field ABC-M17, M17A1, M17A2	TM 3-4240-279-10
Operator's Manual for Mask, Chemical-Biological: Aircraft,	
ABC-M24, and Accessories and Mask, Chemical-Biological, Tank,	
M25A1 and Accessories	TM 34240-280-10
Operator's Manual for Chemical-Biological Mask:	
Field M40	3-4240-300-10-1
Operator's Manual for Chemical-Biological Mask:	
Combat Vehicle M42	3-4240-300-10-2

TM 10-8415-209-10
TM 8415-10/2

Operator's and Unit Maintenance Manual for Mask Chemical-Biological, Aircraft, M43, Type I	3-4240-312-12&P
General Repair Procedures for Clothing	TM 10-8400-201-23
General Repair Procedures for Individual Equipment	TM 10-8400-203-23

APPENDIX B
COMPONENTS OF END ITEM AND BASIC ISSUE ITEMS LISTS

Section I. INTRODUCTION

B-1. SCOPE. This appendix lists components of the end items (COEI) and basic issue items (BII) for the Individual Chemical Protective Clothing Items to help you to inventory the items for safe and efficient operation of the equipment.

B-2. GENERAL. The component of end item and basic issue items lists are divided into two sections:

a. Section II, Components of End Item. This listing is for information purposes only, and is not authority for you to requisition replacements. These items are part of the Individual Chemical Protective Clothing items.

b. Section III, Basic Issue Items. These essential items are required to place the Individual Chemical Protective Clothing items in operation, operate them, and do emergency repairs. Although shipped separately packaged, BII must be with the

Individual Chemical Protective Clothing items during operation and when transferred between property accounts. Listing these items is your authority to requisition them for replacement based on authorization of end item by the TOE/MTOE. Illustrations are furnished to help you identify the items.

B-3. EXPLANATION OF COLUMNS.

- a. Column (1). Illustration Number. Not applicable.
- b. Column (2) National Stock Number. Identifies the stock number of the item used for requisitioning purposes.
- c. Column (3) Description and Usable On Code. Identifies the Federal item name (in all capital letters) followed by a minimum description when needed. The last line below the description is the CAGEC (Commercial And Government Entity Code) (in parenthesis) and the part number.

d. Column (4) U/I (Unit of Issue). Indicates how the item is issued for the National Stock Number shown in column (1).

e. Column (5) Qty Rqd. Indicates the quantity required.

Section II. COMPONENTS OF END ITEM

(1) Illus.No.	(2) National Stock Number	(3) Description	(4) U/I	(5) Qty
	841541470-1880 841541-070-1879 8415-01407-1060 8415-01-177-5077 8415-01-177-5008 8415-01-407-1062 8415-01-407-1063 8415-01-407 1064	SUIT, CHEMICAL PROTECTIVE, OVERGARMENT (CPOG) Size XXX-S Size XX-S Size X-S Size S Size M Size L Size X-L Size XX L	EA	1

(1) Illus.No.	(2) National Stock Number	(3) Description	(4) U/I	(5) Qty
		SUIT, CHEMICAL PROTECTIVE, 3 COLOR DESERT CAMOUFLAGE (BDO)	EA	1
	8415-01-327-5346	Size XXX-S		
	8415-01-327-5347	Size XX-S		
	8415-01-327-5348	Size X-s		
	8415-01-327-5349	Size S		
	8415-01-327-5350	Size M		
	8415-01-327-5351	Size L		
	8415-01-327-5352	Size X-L		
	8415-01-327-5353	Size XX-L		
		SUIT, CHEMICAL PROTECTIVE 6 COLOR DESERT CAMOUFLAGE (BDO)	EA	1
	8415-01-324-3084	Size XXX-S		
	8415-01-324-3085	Size XX-S		
	8415-01-324-3086	Size X-S		
	8415-01-324-3087	Size S		
	8415-01-324-3088	Size M		
	8415-01-324-3089	Size L		
	8415-01-324-3090	Size X-L		
	8415-01-324-3091	Size XX-L		

(1) Illus.No.	(2) National Stock Number	(3) Description	(4) U/I	(5) Qty
	8415-01-137-1700 8415-01-137-1701 8415-01-137-1702 8415-01-137-1703 8415-01-137-1704 8415-01-137-1705 8415-01-137-1706 8415-01-137-1707	SUIT, CHEMICAL PROTECTIVE, WOODLAND CAMOUFLAGE (BDO) Size XXX-S Size XX-S Size X-S Size S Size M Size L Size X-L Size XX-L	EA	1

(1) Illus.No.	(2) National Stock Number	(3) Description	(4) U/I	(5) Qty
	8415-01-333-7577 8415-01-333-7578 8415-01-333-1579 8415-01-333-7580	SUIT, CHEMICAL AND BIOLOGICAL PROTECTIVE, CARBON SPHERE, DESERT CAMOUFLAGE (SARATOGA) Size S Size M Size L Size X-L	EA	1
	8415-01-333-7573 8415-01-333-7574 8415-01-333-7575 8415-01-333-7576	SUIT, CHEMICAL AND BIOLOGICAL PROTECTIVE, CARBON SPHERE (SARATOGA) Size S Size M Size L Size X-L	EA	1

(1) Illus.No.	(2) National Stock Number	(3) Description	(4) U/I	(5) Qty
		COAT, CHEMICAL PROTECTIVE, AIRCREW FLAME RESISTANT (AUIB), TAN 380	EA	1
	8415-01-326-2629	Size XSm/XSht		
	8415-01-326-2630	Size XSm/Sht		
	8415-01-326-2631	Size Sm/XSht		
	8415-01-326-2632	Size Sm/Sht		
	8415-01-326-2633	Size Sm./Reg		
	8415-01-326-2634	Size Sm/Lng		
	8415-01-326-2635	Size M/XSht		
	8415-01-326-2636	Size M/Sht		
	8415-01-326-2637	Size M/Reg		
	8415-01-326-2638	Size M/Lng		
	8415-01-326-2639	Size Lrg/Sht		
	8415-01-326-2640	Size Lrg/Reg		
	8415-01-326-2641	Size Lrg/		
	8415-01-326-2642	Size XLrg/Reg		
	8415-01-326-2643	Size XLrg/Lng		

(1) Illus.No.	(2) National Stock Number	(3) Description	(4) U/I	(5) Qty
		COAT, CHEMICAL PROTECTIVE, AIRCREW, FLAME RESISTANT (AUIB), WOODLAND CAMOUFLAGE	EA	1
	8415-01-360-4658	Size XSm/XSht		
	8415-01-360-4659	Size XSm/Sht		
	8415-01-360-4660	Size Sm/XSht		
	8415-01-360-4661	Size Sm/Sht		
	8415-01-360-4662	Size Sm/Reg		
	8415-01-360-4663	Size Sm/Lng		
	8415-01-360-4664	Size M/XSht		
	8415-01-360-4665	Size M/Sht		
	8415-01-360-4666	Size M/Reg		
	8415-01-360-4667	Size M/Lng		
	8415-01-360-4668	Size Lrg/Sht		
	8415-01-360-4669	Size Lrg/Reg		
	8415-01-360-4670	Size Lrg/Lng		
	8415-01-360-4671	Size XLrg/Reg		
	8415-01-360-4672	Size XLrg/Lng		

(1) Illus.No.	(2) National Stock Number	(3) Description	(4) U/I	(5) Qty
		TROUSERS, CHEMICAL PROTECTIVE AIRCREW, FLAME RESISTANT, (AUIB)	EA	1
	8415-01-326-2644	Size XSm/Sht		
	8415-01-326-2645	Size Sm/XSht		
	8415-01-326-2646	Size Sm/Sht		
	8415-01-326-2647	Size Sm/Reg		
	8415-01-326-2648	Size Sm/Lng		
	8415-01-326-2649	Size M/X Sht		
	8415-01-326-2650	Size M/Sht		
	8415-01-326-2651	Size M/Reg		
	8415-01-326-2652	Size M/Lng		
	8415-01-326-2653	Size Lrg/Sht		
	8415-01-326-2654	Size Lrg/Reg		
	8415-01-326-2625	Size Lrg/Lng		
	8415-01-326-2626	Size XLrg/Sht		
	8415-01-326-2627	Size XLrg/Reg		
	8415-01-326-2628	Size XLrg/Lng		

(1) Illus.No.	(2) National Stock Number	(3) Description	(4) U/I	(5) Qty
		TROUSERS, CHEMICAL PROTECTIVE, AIRCREW, FLAME RESISTANT, (AUIB) WOODLAND CAMOUFLAGE	EA	1
	8415-01-360-5764	Size XSm/Sht		
	8415-01-360-5765	Size Sm/XSht		
	8415-01 -360-5766	Size Sm/Sht		
	8415-01 -360-5767	Size Sm/Reg		
	8415-01 -360-5768	Size Sm/Lng		
	8415-01 -360-5769	Size M/XSht		
	8415-01-360-5770	Size M/Sht		
	8415-01-360-5771	Size M/Reg		
	8415-01-360-5772	Size M/Lng		
	8415-01-360-5773	Size Lrg/Sht		
	8415-01-360-5774	Size Lrg/Reg		
	8415-01-360-5775	Size Lrg/Lng		
	8415-01-360-5776	Size XLrg/Sht		
	8415-01-360-5777	Size XLrg/Reg		
	8415-01-360-5778	Size XLrg/Lng		

(1) Illus.No.	(2) National Stock Number	(3) Description	(4) U/I	(5) Qty
	8415-01-333 0987 8415-01-333-0988 8415-01-333-0989	PONCHO & TROUSERS: SUIT, CONTAMINATION AVOIDANCE, LIQUID PROTECTIVE (SCALP), TAN 380 Size S Size M/L Size XL/XXL	EA	1
	8415-01-364-3320 8415-01-364-3321 8415-01-364-3322	PONCHO & TROUSERS: SUIT, CONTAMINATION AVOIDANCE LIQUID PROTECTIVE (SCALP), GREEN 483 Size S Size M/L Size XL/XXL	EA	1

(1) Illus.No.	(2) National Stock Number	(3) Description	(4) U/I	(5) Qty
	8415-01-333-0990 8415-01-333-0991 8415-01-333-0992	FOOTWEAR COVERS: SUIT, CONTAMINATION AVOIDANCE, LIQUID PROTECTIVE (SCALP), TAN 380 Size S Size M Size L	PR	1
	8415-01-364-3458 8415-01-364-3459 8415-01-364-3460	FOOTWEAR COVERS: SUIT CONTAMINATION AVOIDANCE, LIQUID PROTECTIVE (SCALP), GREEN 483 Size S Size M Size L	PR	1

(1) Illus.No.	(2) National Stock Number	(3) Description	(4) U/I	(5) Qty
		OVERSHOES, MENS AND WOMENS, BOOT, COMBAT, GREEN (GVO)	PR	1
	8430-01-048-6305	Size 3		
	8430-01-048-6306	Size 4		
	8430-01-049-0878	Size 5		
	8430-01-049-0879	Size 6		
	8430-01-049-0880	Size 7		
	8430-01-049-0881	Size 8		
	8430-01-049-0882	Size 9		
	8430-01-049-0883	Size 10		
	8430-01-049-0884	Size 11		
	8430-01-049-0885	Size 12		
	8430-01-049-0886	Size 13		
	8430-01-049-0887	Size 14		

(1) Illus.No.	(2) National Stock Number	(3) Description	(4) U/I	(5) Qty
	8430-01-317-3374 8430-01-317-3375 8430-01-317-3376 8430-01-317-3377 8430-01-317-3378 8430-01-317-3379 8430-01-317-3380 8430-01-317-3381 8430-01-317-3382 8430-01-317-3383 8430-01-317-3384 8430-01-317-3385	OVERSHOES, MENS AND WOMENS, BOOT, COMBAT, GREEN (GVO) OR BLACK (BVO) Size 3 Size 4 Size 5 Size 6 Size 7 Size 8 Size 9 Size 10 Size 11 Size 12 Size 13 Size 14	PR	1
	8430-01-118-8172 8430-01-021-5978	FOOTWEAR COVER, CHEMICAL PROTECTIVE (CPFC) Size S Size L	PR	1

(1) Illus.No.	(2) National Stock Number	(3) Description	(4) U/I	(5) Qty
	8415-01-138-2497 8415-01-138-2498 8415-01-138-2499 8415-01-138-2500 8415-01-144-1862 8415-01-033-3517 8415-01-033-3518 8415-01-033-3519 8415-01-033-3520 8415-01-138-2501 8415-01-138-2502 8415-01-138-2503 8415-01-138-2504	GLOVE SET, CHEMICAL PROTECTIVE, 14 MIL Size S Size M Size L Size X-L GLOVE SET, CHEMICAL PROTECTIVE, 25 MIL Size X-S Size S Size M Size L Size X-L GLOVE SET, CHEMICAL PROTECTIVE, 7 MIL Size S Size M Size L Size X-L	EA	1

(1) Illus.No.	(2) National Stock Number	(3) Description	(4) U/I	(5) Qty
	8415-01-111-9028	COVER, HELMET (PASGT), CHEMICAL PROTECTIVE (one size/color only)	EA	1
		UNDERSHIRT; UNDERWEAR CHEMICAL PROTECTIVE, TWO PIECE (CPU)	EA	1
	8415-01-363-8692	Size 32		
	8415-01-363-8693	Size 34		
	8415-01-363-8694	Size 36		
	8415-01-363-8695	Size 38		
	8415-01-363-8696	Size 40		
	8415-01-363-8697	Size 42		
	8415-01-363-8698	Size 44		
	8415-01-363-8699	Size 46		
	8415-01-363-8700	Size 48		

(1) Illus.No.	(2) National Stock Number	(3) Description	(4) U/I	(5) Qty
	8415-01-363-8683 8415-01-363-8684 8415-01-363-8685 8415-01-363-8686 8415-01-363-8687 8415-01-363-8688 8415-01-363-8689 8415-01-363-8690 8415-01-363-8691	DRAWERS, UNDERWEAR CHEMICAL PROTECTIVE, TWO PIECE (CPU) Size 26 Size 28 Size 30 Size 32 Size 34 Size 36 Size 38 Size 40 Size 42	EA	1

Section III. BASIC ISSUE ITEMS

(1) Illus.No.	(2) National Stock Number	(3) Description	(4) U/I	(5) Qty
		OPERATOR'S TM FOR INDIVIDUAL CHEMICAL PROTECTIVE CLOTHING ITEMS US ARMY TM 10-8415-209-10 US MARINE CORPS TM 8415-10/2	EA	1

APPENDIX C
ADDITIONAL AUTHORIZATION LIST

(not applicable)

C-1/(C-2 blank)

APPENDIX D EXPENDABLE/DURABLE ITEMS LIST

Section I. INTRODUCTION

D-1. SCOPE. This appendix lists expendable and durable items that you will need to operate and maintain your Individual Chemical Protective Clothing items. This list is for information only and is not authority to requisition the listed items. These items are authorized to you by CTA 50-970, Expendable/Durable Items (except medical, class v repair parts, and heraldic items), or CTA 8-100, Army Medical Department Expendable/Durable Items.

D-2. EXPLANATION OF COLUMNS.

a. Column 1. Item Number. This number is assigned to the entry in the listing and is referenced in the narrative instructions to identify the item (e.g., "Use cleaning compound, Appendix D, item 5.").

- b. Column 2. Level. This column identifies the lowest level of maintenance that requires the item.
- c. Column 3. National Stock Number. This is the National Stock Number (NSN) assigned to the item, which you can use to requisition it.
- d. Column 4. Item Name. Description. Commercial and Government Agency Entity Code (CAGEC, and Part Number. This provides other information you need to identify the item.
- e. Column 5. Unit of Measure. This code shows the physical measurement or count of an item, such as gallon, dozen, gross, etc.

Section II. EXPENDABLE/DURABLE ITEMS LIST

(1) Item No	(2) Level	(3) National Stock No.	(4) Item Name, Description CAGEC Part Number	(5) U/M
1	C	5640-00-103-2254	Duct tape	RL
2	C	7930-00-252-6797	Detergent, laundering	BG
3	C	7930-00-291-8321	Sour, laundering	DR
4	C	6810-00-949-8331	Powder detergent, sodium hexameda phosphate	DR
5	C	7930-00-224-7901	Laundry soap, powder	DR
6	C	7930-00-252-0509	Sour-softener, sodium acid fluoride	DR

GLOSSARY

AUIB	Aircrew Uniform, Integrated Battlefield
BDO	Battle Dress Overgarment
BG	Bag
BVO	Black Vinyl Overshoes
CPOG	Chemical Protective Overgarments
CPU	Chemical Protective Underwear
Decon	Decontamination
DR	Drum
DS2	Decontamination Solution #2
EA	Each
EIR	Equipment Improvement Recommendations
GVO	Green Vinyl Overshoes
IAW	In accordance with
JTA	Joint Table of Allowances
MOPP	Mission Oriented Protective Posture

MTOE	Modified Table of Organizational Equipment
OG84	Overgarment 84
PASGT	Personnel Armor System, Ground Troop
POLs.....	Petroleum, Oils, and Lubricants
RL.....	Roll
SCALP	Suit, Contamination Avoidance, Liquid Protective
TDA	Table of Distribution and Allowances
TOE	Table of Organizational Equipment
U/M.....	Unit of Measure

GLOSSARY 2

ALPHABETICAL INDEX

	Paragraph
A	
Additional Authorization List.....	C-1
AUIB, doffing	2-9
donning.....	2-8
B	
Basic issue items list.....	B-1
C	
Checks and services, preventive maintenance.....	2-1
Components, description of major	1-6
Components, of end item list	B-1
Chemical protective overgarment) donning	2-5
donning.....	2-4
Chemical protective underwear (CPU), doffing.....	2-3
donning.....	2-2
laundering	3-2
Cross reference, nomenclature.....	1-5
D	
Description of major components	1-6
Destruction of Army materiel to prevent enemy use	1-3

Differences between models	1-7
Doffing	
AUIB	2-9
Chemical protective overgarments	2-5
CPU	2-3
Saratoga suit	2-7
SCALP	2-11
Donning	
AUIB	2-8
Chemical protective overgarments	2-4
CPU	2-2
Saratoga	2-6
SCALP	2-10
Durable supplies and materials List, expendable	D-1
E	
Equipment improvement recommendations, reporting	1-4
Expendable/durable supplies and materials List	D 1
F	
Forms and procedures, maintenance	1-2
G	
General information	1-1

H	
I	
Improvement recommendations, reporting equipment	1-4
Instructions, operating.....	2-2 -2-11
Instructions, maintenance	3-1
L	
Laundering the chemical protective underwear (CPU).....	3-2
Laundering the suit, chemical and biological protective, carbon sphere (Saratoga).....	3-3
List, nomenclature cross reference	1-5
Location and description of major components.....	1-6
M	
Maintenance, Instructions	3-1
Maintenance checks and services, preventive	2-1
Major components, location and description of.....	1-6
Materials list, expendable/durable supplies	D-1
Mission oriented protective posture (MOPP)	1-8
Models differences between.....	1-7
N	
Nomenclature cross reference list	1-5

O	
Operating instructions	2-2 - 2-11
Operation, Principles.....	1-8
P	
Preventive maintenance checks and services.....	2-1
Prevent enemy use, destruction of Army materiel to	1-3
Principles of operation.....	1-8
R	
References.....	A-1
Reporting equipment improvement recommendations	1-4
S	
Saratoga suit, doffing	2-7
donning.....	2-6
laundering	3-3
SCALP, doffing	2-11
donning.....	2-10
Scope.....	1-1
Supplies and materials list, expendable durable.....	D-1
U	
Usual conditions operation under.....	2-2 - 2-11

By Order of the Secretaries of the Army and Navy (Including the Marine Corps):

Official:

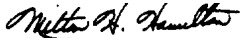

MILTON H. HAMILTON
*Administrative Assistant to the
Secretary of the Army*

RONALD D. ELLIOT
Executive Director
Marine Corps Systems Command

GORDON R. SULLIVAN
*General, United States Army
Chief of Staff*

DISTRIBUTION:

To be distributed in accordance with DA Form 12-25-E, block no. 6033, requirements for TM 10-8415-209-10.

RECOMMENDED CHANGES TO EQUIPMENT TECHNICAL PUBLICATIONS



THEN...JOT DOWN THE DOPE ABOUT IT ON THIS FORM. CAREFULLY TEAR IT OUT, FOLD IT AND DROP IT IN THE MAIL.

SOMETHING WRONG WITH PUBLICATION

FROM: (PRINT YOUR UNIT'S COMPLETE ADDRESS)

DATE SENT

PUBLICATION NUMBER

PUBLICATION DATE

PUBLICATION TITLE

BE EXACT PIN-POINT WHERE IT IS

PAGE NO.	PARA-GRAPH	FIGURE NO.	TABLE NO.

IN THIS SPACE, TELL WHAT IS WRONG AND WHAT SHOULD BE DONE ABOUT IT.

PRINTED NAME, GRADE OR TITLE AND TELEPHONE NUMBER

SIGN HERE

THE METRIC SYSTEM AND EQUIVALENTS

WEIGHT MEASURE

1 Centimeter = 10 Millimeters = 0.01 Meters = 0.3937 Inches
 1 Meter = 100 Centimeters = 1000 Millimeters = 39.37 Inches
 1 Kilometer = 1000 Meters = 0.621 Miles

WEIGHTS

1 Gram = 0.001 Kilograms = 1000 Milligrams = 0.035 Ounces
 1 Kilogram = 1000 Grams = 2.2 lb.
 1 Metric Ton = 1000 Kilograms = 1 Megagram = 1.1 Short Tons

LIQUID MEASURE

1 Milliliter = 0.001 Liters = 0.0338 Fluid Ounces
 1 Liter = 1000 Milliliters = 33.82 Fluid Ounces

SQUARE MEASURE

1 Sq. Centimeter = 100 Sq. Millimeters = 0.155 Sq. Inches
 1 Sq. Meter = 10,000 Sq. Centimeters = 10.76 Sq. Feet
 1 Sq. Kilometer = 1,000,000 Sq. Meters = 0.386 Sq. Miles

CUBIC MEASURE

1 Cu. Centimeter = 1000 Cu. Millimeters = 0.06 Cu. Inches
 1 Cu. Meter = 1,000,000 Cu. Centimeters = 35.31 Cu. Feet

TEMPERATURE

$5/9(^{\circ}\text{F} - 32) = ^{\circ}\text{C}$
 212° Fahrenheit is equivalent to 100° Celsius
 90° Fahrenheit is equivalent to 32.2° Celsius
 32° Fahrenheit is equivalent to 0° Celsius
 $9/5^{\circ}\text{C} + 32 = ^{\circ}\text{F}$

APPROXIMATE CONVERSION FACTORS

TO CHANGE	TO	MULTIPLY BY
Inches	Centimeters	2.540
Feet	Meters	0.305
Yards	Meters	0.914
Miles	Kilometers	1.609
Square Inches	Square Centimeters	6.451
Square Feet	Square Meters	0.093
Square Yards	Square Meters	0.836
Square Miles	Square Kilometers	2.590
Acres	Square Hectometers	0.405
Cubic Feet	Cubic Meters	0.028
Cubic Yards	Cubic Meters	0.765
Fluid Ounces	Milliliters	29.573
its	Liters	0.473
arts	Liters	0.946
allons	Liters	3.785
Ounces	Grams	28.349
Pounds	Kilograms	0.454
Short Tons	Metric Tons	0.907
Pound-Feet	Newton-Meters	1.356
Pounds per Square Inch	Kilopascals	6.895
Miles per Gallon	Kilometers per Liter	0.425
Miles per Hour	Kilometers per Hour	1.609

TO CHANGE	TO	MULTIPLY BY
Centimeters	Inches	0.394
Meters	Feet	3.280
Meters	Yards	1.094
Kilometers	Miles	0.621
Square Centimeters	Square Inches	0.155
Square Meters	Square Feet	10.764
Square Meters	Square Yards	1.196
Square Kilometers	Square Miles	0.386
Square Hectometers	Acres	2.471
Cubic Meters	Cubic Feet	35.315
Cubic Meters	Cubic Yards	1.308
Milliliters	Fluid Ounces	0.034
Liters	Pints	2.113
Liters	Quarts	1.057
ers	Gallons	0.264
ms	Ounces	0.035
ograms	Pounds	2.205
Metric Tons	Short Tons	1.102
Newton-Meters	Pounds-Feet	0.738
Kilopascals	Pounds per Square Inch	0.145
ometers per Liter	Miles per Gallon	2.354
ometers per Hour	Miles per Hour	0.621

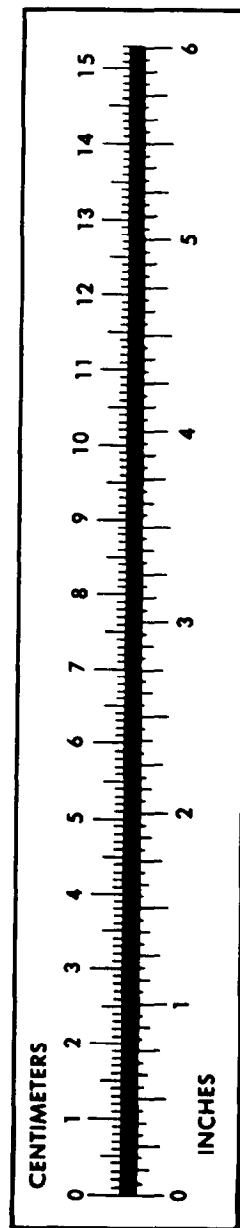

PIN: 071248-000